



**POLARIS**

**2025**

**SNOW ACCESSORIES,  
GARAGE & APPAREL**



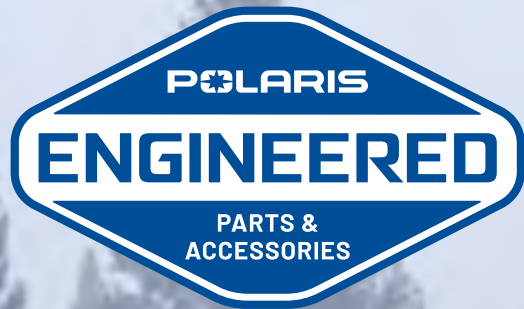

# 2025

Thank you for choosing Polaris. Everything in our Snow Accessories, Garage and Apparel lineup is designed to optimize your experience on every ride. Customize your sled for your individual riding style with our collection of accessories. Use Polaris Engineered parts and lubricants, and your sled will deliver peak reliability and performance, season after season. Stay warm and dry in our technical riding gear for a more enjoyable ride.

## ACCESSORIES

- 6 Lock & Ride Flex
- 8 Polaris Partners
- 10 Connected Technology
- 12 MATRYX
- 38 AXYS
- 52 PRO-RIDE
- 58 Ride Readiness
- 60 Color Customization
- 62 Transport
- 64 Traction & Control
- 66 Tracks

## GARAGE

- 72 Maintenance
- 74 Oil
- 78 Lubricants & Garage Accessories
- 80 Belts, HD Parts & Battery Chargers
- 82 Polaris Power
- 84 Service Parts

## APPAREL

- 88 Riding Gear 101
- 90 TECH54
- 92 Men's Apparel
- 110 UNRL® x Polaris
- 112 Polaris Heated Apparel
- 114 Women's Apparel
- 126 Youth Apparel
- 130 Helmets
- 140 Goggles
- 142 Rider Safety
- 146 Hats
- 148 Gloves
- 150 Boots, Balaclavas & Luggage
- 152 Home & Collectibles

## DESIGNED

Developed by the same engineers who built your sled.

## TESTED

Proven in grueling winter conditions around the world.

## TRUSTED

Over 70 years of building the world's best snowmobiles.



### RMK

THE WORLD'S BEST PURPOSE-BUILT MOUNTAIN SLEDS.



### SWITCHBACK

ON-TRAIL COMFORT WITH OFF-TRAIL CAPABILITY.



### INDY

REDEFINING TRAIL PERFORMANCE.



### TITAN

HARDEST WORKING, MOST FUN WIDETRACK.



### VOYAGEUR

WORK. EXPLORE. DO MORE.

EXPLORE OUR FULL LINEUP [POLARIS.COM](https://www.polaris.com)

# ACCESSORIES FOR YOUR ULTIMATE RIDE.

Make the best even better. Designed, engineered and tested to the same demanding standards as our snowmobiles, Polaris Engineered accessories perfectly complement how you ride. This means they fit perfectly, mount effortlessly, and perform to the highest standards in the backcountry, on the trail and everywhere in between.

## ACCESSORY CONTENTS

- 6 Lock & Ride Flex
- 8 Polaris Partners
- 10 Connected Technology
- 12 MATRYX
- 38 AXYS
- 52 PRO-RIDE
- 58 Ride Readiness
- 60 Color Customization
- 62 Transport
- 64 Traction & Control
- 66 Tracks



SCAN TO VISIT THE  
ACCESSORY INSTALL  
INSTRUCTION PORTAL



# RIDER ACCESSORY COLLECTIONS

## EXPLORE THE POSSIBILITIES

These collections are your snowmobile upgrade cheat code. We've picked the top-selling gear and hottest accessories, then bundled them up based on how you conquer the snow. Whether you're a summit seeker, trail tamer, or weekend warrior, there's a collection that's your perfect match.



## TRAIL

ESSENTIALS	2889863	Auxiliary Punch Light	P. 18
	2884455	<b>LR</b> Adventure Tunnel Bag - Low	P. 14
	2890669	Ultimate Knee Pads	P. 22
	2889255	Adjustable Windshield	P. 24
	2884817	Sentry Front Bumper	P. 29
	2884456	<b>LR</b> Adventure Tunnel Bag - Tall	P. 14
STORAGE	2884453	<b>LR</b> Sport Tunnel Bag - Low	P. 14
	2884454	<b>LR</b> Sport Tunnel Bag - Tall	P. 14
	2890449	<b>LR</b> Adventure Box	P. 14

COMFORT	2889733	Auxiliary Flood Light	P. 18
	2890566	Grill Insert RGB Accent Lights	P. 18
	2890509	Handguard RGB Accent Lights	P. 19
	2884616	Defend Handguards	P. 23
	2884617	Defend Handguard Mounts	P. 23
	2890103	Insight Side Mirrors	P. 23
PROTECTION	2890614	Trail Handlebar Pad	P. 23
	2891077	Trail Heated Driver Seat	P. 27
	2884979	Grill Inserts	P. 28
	2884816	Sentry Skid Plate	P. 28
	2884257	Sentry Trail Rear Bumper	P. 29



LEARN MORE ABOUT THE TRAIL COLLECTION AT  
[SNOWMOBILES.POLARIS.COM/TRAILCOLLECTION](https://snowmobiles.polaris.com/trailcollection)

## CROSSOVER

ESSENTIALS	2889863	Auxiliary Punch Light	P. 18
	2889258	<b>LR</b> Burandt Bag - Medium	P. 15
	2890669	Ultimate Knee Pads	P. 22
	2884616	Defend Handguards	P. 23
	2884617	Defend Handguard Mounts	P. 23
	2884455	<b>LR</b> Adventure Tunnel Bag - Low	P. 14
STORAGE	2884453	<b>LR</b> Sport Tunnel Bag - Low	P. 14
	2884454	<b>LR</b> Sport Tunnel Bag - Tall	P. 14

COMFORT	2889733	Auxiliary Flood Light	P. 18
	2890566	Grill Insert RGB Accent Lights	P. 18
	2890509	Handguard RGB Accent Lights	P. 19
	2891077	Trail Heated Driver Seat	P. 27
	2884979	Grill Inserts	P. 28
	2884816	Sentry Skid Plate	P. 28
PROTECTION	2884817	Sentry Front Bumper	P. 29
	2884257	Sentry Trail Rear Bumper	P. 29



LEARN MORE ABOUT THE CROSSOVER COLLECTION AT  
[SNOWMOBILES.POLARIS.COM/CROSSOVERCOLLECTION](https://snowmobiles.polaris.com/crossovercollection)

## MOUNTAIN

ESSENTIALS	2889258	<b>LR</b> Burandt Bag - Medium	P. 15
	2890666	Ultimate Knee Pads	P. 22
	2889868	RMK Backcountry Handguards	P. 22
	2884817	Sentry Front Bumper	P. 29
	2884816	Sentry Skid Plate	P. 28
	2889257	RMK Essentials Bag	P. 15
STORAGE	2889259	<b>LR</b> Burandt Bag - Large	P. 15
	2889322	Spare Shovel Jacket	P. 15
	2882823	Goggle Handlebar Bag	P. 16

PROTECTION	2884979	Grill Inserts	P. 28
	2889351	Sentry Mountain Rear Bumper - 146"	P. 29
	2889352	Sentry Mountain Rear Bumper - 155"	P. 29
	2889353	Sentry Mountain Rear Bumper - 155" / 163" / 165"	P. 29



LEARN MORE ABOUT THE MOUNTAIN COLLECTION AT  
[SNOWMOBILES.POLARIS.COM/MOUNTAINCOLLECTION](https://snowmobiles.polaris.com/mountaincollection)



## CUSTOMIZE YOUR CONFIGURATION FOR THE WAY YOU RIDE.

Lock & Ride Flex enables multiple configurations to easily add storage and passenger seating to your snowmobile in one simple click. Explore how you can make it your own with Lock & Ride Flex.



RETROFIT YOUR SLED WITH

Unlock a world of quick-swap storage, racks, and gear that adapts to your every adventure. From powder days to weekend getaways, transform your snowmobile on the fly and experience the freedom of endless possibilities.

### LOCK & RIDE FLEX ADAPTER KIT

AXYS PRO-RIDE

• Add Lock & Ride Flex storage to AXYS and Pro-Ride full tunnel sleds

2884939 **★ TOP SELLER**

ALL PRO-RIDE & AXYS SLEDS W/ TUNNEL T-SLOTS, NOT COMPATIBLE WITH LOCK & RIDE FLEX M2 SEAT

## EASY & SECURE

Customize Your Lock & Ride Flex Configuration for your Tunnel Length.

- Push to secure
- Lift to release
- No turning, no twisting
- Customizable configurations
- Retro-fit compatible

### 121" TUNNEL AND LONGER

SPORT TUNNEL BAG - TALL



1 SMALL

### 128" - 146" TUNNEL AND LONGER

ADVENTURE BOX



1 MEDIUM OR 2 SMALL

### 155" TUNNEL AND LONGER

BURANDT BAG - LARGE



1 LARGE OR 1 MEDIUM + 1 SMALL OR 3 SMALL

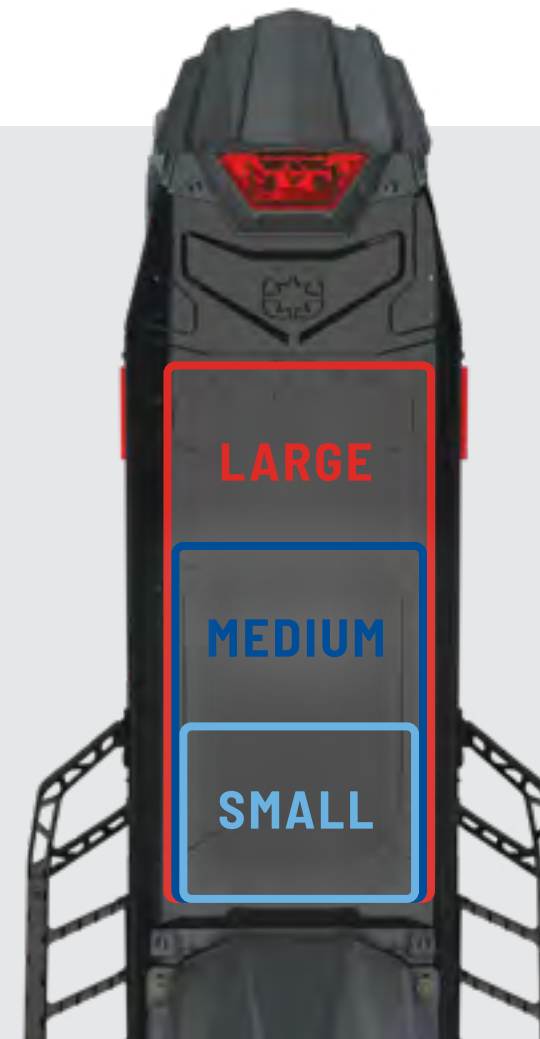

### SMALL



- 2884453 Sport Tunnel Bag - Low
- 2884454 Sport Tunnel Bag - Tall
- 2884957 M2 Seat - Heated
- 2884725 M2 Seat - Standard
- 2890008 Waterproof Roll-Top Bag
- 2890496 Trail Jump Seat

### MEDIUM



- 2884455 Adventure Tunnel Bag - Low\*
- 2884456 Adventure Tunnel Bag - Tall\*
- 2889258 Burandt Bag - Medium\*
- 2889228 M2 Journey Bag
- 2890599 Adventure Rack Bag
- 2890018 Adventure Rack\*\*
- 2890449 Adventure Box **NEW**

### LARGE



- 2889259 Burandt Bag - Large\*



\*Additional color options available.  
\*\* 136" tunnel and longer.

LEARN MORE AT [POLARIS.COM/LOCKRIDEFLEX](https://POLARIS.COM/LOCKRIDEFLEX)

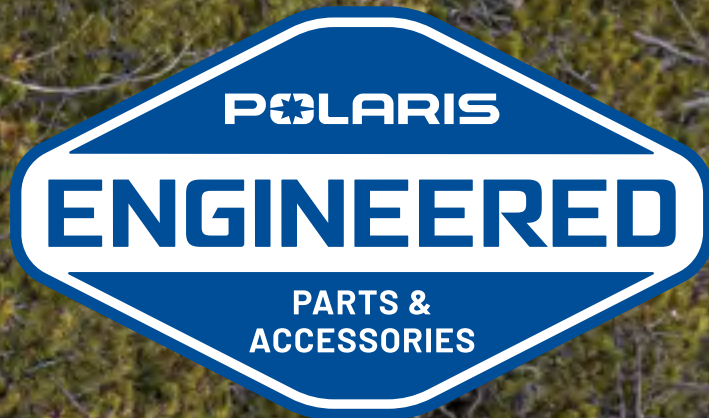

**DESIGNED**  
by the people who  
designed your vehicle.

**TESTED**  
in the field so you ride with  
100% confidence.

**TRUSTED**  
70 years in the business.  
The Original Snowmobile Company.

BACKED BY A



WARRANTY



KEEP YOUR  
STANDARDS HIGH.  
WE DO.



Sharing an outdoor adventure with a companion or two gives your experience its very own energy. When we meet another brand that builds and tests their products with the same rigor as we do, a kinship forms. So we give them an exclusive partner badge and invite them along for the ride. It's another way we bring you the best options for customizing your Polaris vehicle without compromise.



P. 30



P. 31



P. 36



P. 59



P. 61



P. 61



P. 62



P. 64



P. 66

# POLARIS RIDE COMMAND ENHANCE YOUR RIDE

Designed with integrated RIDE COMMAND technology exclusively for the MATRYX platform, the 7S Display brings a whole new level of intuitive, touchscreen control and customization allowing you to ride confidently and comfortably.

LEARN MORE AT  
[SNOWMOBILES.POLARIS.COM/RIDECOMMAND](http://SNOWMOBILES.POLARIS.COM/RIDECOMMAND)



## 7-INCH GLOVE TOUCH COMPATIBLE DISPLAY

Easy control in cold weather.  
Dedicated day and night mode.  
Display adjusts automatically based on ambient light levels.



## TRACK AND COMMUNICATE WITH YOUR RIDE GROUP

Industry leading Vehicle-to-Vehicle Group Ride allows you to see and follow your group - whether you have cellular connectivity or not.  
Records every ride to the display with 64gb of onboard storage, and is fully transferable via USB.  
Send your buddies a Help Alert message to let them know you need assistance while out riding.



## PLAN & NAVIGATE WITH ONBOARD POINTS OF INTEREST

Create and plan your route using the complimentary Polaris mobile app and RIDE COMMAND website.  
View a full set of gas, food, and lodging information all on the industry's leading trail data set.  
Map, trail, and POI data encompasses the entire North American snow belt.  
Seamlessly sync your planned routes, rides, and waypoints to and from your Polaris account.



## 7S DISPLAY POWERED BY RIDE COMMAND MATRYX

- Create and plan your route with on-board maps and trails
- Full set of gas, food, and lodging information available on or off line
- Group Ride feature keeps all riders in sight even when you split up

2884971 **TOP SELLER**  
ALL MATRYX, REQUIRES INSTALL KIT (2890275 OR 2891237), SOLD SEPARATELY

## 7S DISPLAY INSTALL KIT MATRYX

- Required for 7S Display installation
- 2890275  
ALL MATRYX INDY AND SWITCHBACK  
2891237  
ALL MATRYX RMK



SCAN THE QR CODE TO DOWNLOAD THE POLARIS APP FOR FREE



# VOYAGER PRO



## ADD ANY VEHICLE TO YOUR GROUP RIDES

The Trail Tech Voyager Pro GPS seamlessly connects with 7S Display powered by RIDE COMMAND. Join the group and ride. The Voyager Pro is the digital gauge option for riders without a Polaris MATRYX sled. The Voyager Pro is compatible with RIDE COMMAND for streamlined buddy tracking of your entire group, and it comes with several other connected features.

## THE CONNECTED RIDER'S GPS

Featuring Polaris Group Ride compatibility, custom maps, Bluetooth®, a 4" color touchscreen and full vehicle integration with gauges.

## VOYAGER PRO KIT, SNOW

- **4" Touchscreen:** This 4" anti-glare, glove friendly, color touchscreen is visible in all conditions. IP67 rated for anti-dust/water intrusion.
- **Pre-Loaded Base Maps:** The map screen is enabled with base maps, topography lines, hill shading, and select trails. Record or load GPS trails and riding areas, and transfer to a PC.
- **Buddy Tracking:** RIDE COMMAND compatible with ability to track up to 20 ride group members. Cell reception not required.
- **Vehicle Information:** Integrates with your vehicle providing vital ride data such as engine temp, RPM, Speed, and more. Bluetooth® enabled for intercom, phone and media controls.
- Kit includes all mounting hardware, tach sensor, and power connection.

922-122  
AVAILABLE AT YOUR LOCAL DEALER OR ONLINE AT TRAILTECH.NET



# MATRYX

The rider-first MATRYX platform delivers instinctive, intuitive control with breakthrough rider dynamics and such seamless accessory integration that rider and machine become one. These accessories look, feel and function like integral elements of the sled.

## RMK

- 2025 RMK SP 155
- 2023-2024 650 SKS 146
- 2022-2025 PRO RMK 155/165
- 2022-2025 RMK KHAOS 146/155/165
- 2022-2023 RMK KHAOS 163
- 2022-2023 PRO RMK 163

## SWITCHBACK

- 2023-2024 SP 146
- 2021-2025 ASSAULT 146
- 2022-2025 SWITCHBACK XC

## VOYAGEUR

- 2022-2025 146

## TITAN

- 2025 650 TITAN ADVENTURE 155

## INDY

- 2023-2025 INDY SP 137
- 2022-2025 XCR 128/136
- 2022-2025 ADVENTURE 137
- 2022-2024 XC 129/137
- 2022-2023 ADVENTURE X2 137
- 2021-2023 VR1 129
- 2021 XC LAUNCH EDITION 129/137

# ENHANCE YOUR SNOWMOBILE

Enhance an already great sled by customizing it with color-matched accessories for the ultimate in style and personalization. Design your sled to reflect your unique personality.

## HANDGUARDS

Strong, durable handguards install easily and provide outstanding protection for a rider's hands in all conditions.

P. 23

## WINDSHIELDS

Windshields help provide protection from the elements and deflect wind.

P. 24

## LIGHTS

Add to your visibility with our lineup of Auxiliary Lighting and give your machine a custom look.

P. 18

## GRILL INSERTS

Stand out on the trails in style with custom painted Grill Insert. Color matched, these grill inserts fit seamlessly into the overall design, letting you easily achieve the custom, stylish look you want your sled to have.

P. 28

## FRONT BUMPERS

The front bumper on a snowmobile is a multifunctional component that provides protection, customization options, and utility.

P. 29

## SPINDLES

Customize your snowmobile's independent front suspension to match your style. Spindles play a key role in the sled's steering and handling characteristics.

P. 60

## REAR BUMPERS

Adds a custom look and great protection to your sled. Rear grab bar is easy to use with gloved hands.

P. 29

## STORAGE

If you want extra gear, storage is a must. With our Lock & Ride Flex system, storage is seamless, configurable & effective.

P. 14

## SEAT

A comfortable seat improves the overall experience of your ride and heated variants offer another level of comfort, providing warmth on those extra cold days.

P. 26

## SKIS

A good pair of skis are vital for your snowmobile's performance, handling & control.

P. 60

## SKI TOES

Customize your snowmobile's skis with the fresh new ski toe design. Match the color with your sled to show off your unique style.

P. 60

## SKID PLATES

Skid plates deliver protection for the bottom of your sled helping to prevent wear & tear to critical components on your machine.

P. 28

## MATRYX - STORAGE

LOW  
10  
LITERS



TALL  
15  
LITERS

### LR FLEX SPORT TUNNEL BAG

MATRYX AXYS PRO-RIDE



- Semi-rigid design available in two profiles; fits great with M2 seat
- Oversized buckles provide easy access to gear with your gloves on
- Keep your items organized and secure inside with Velcro® adjustable dividers

- Base is water-resistant to keep your gear dry
- Installation on AXYS and Pro-Ride sleds requires the Lock & Ride Flex Adapter Kit (2884939), sold separately

Low | 2884453

ALL MATRYX, ALL AXYS & PRO-RIDE 121 AND LONGER WITH FULL TUNNEL AND LOCK & RIDE FLEX ADAPTER KIT

Liner Bag - Small | 2889260

Tall | 2884454 **★ TOP SELLER**

ALL MATRYX, ALL AXYS & PRO-RIDE 121 AND LONGER WITH FULL TUNNEL AND LOCK & RIDE FLEX ADAPTER KIT

Liner Bag - Large | 2889261

23  
LITERS



TALL  
35  
LITERS

### LR FLEX ADVENTURE TUNNEL BAG

MATRYX AXYS PRO-RIDE



- Semi-rigid design available in two profiles
- Oversized buckles provide easy access to gear with your gloves on
- Keep your items organized and secure inside with Velcro® adjustable dividers

- Base is water-resistant to keep your gear dry
- Installation on AXYS and Pro-Ride sleds requires the Lock & Ride Flex Adapter Kit (2884939), sold separately

LOW

Black | 2884455 **★ TOP SELLER**

Liner Bag - Small | 2889262

#### CARBON FIBER COLOR OPTIONS

■ Sky Blue	2890622
■ Neon	2890623

ALL MATRYX, ALL AXYS & PRO-RIDE 128 AND LONGER WITH FULL TUNNEL AND LOCK & RIDE FLEX ADAPTER KIT



TALL

Black | 2884456 **★ TOP SELLER**

Liner Bag - Large | 2889263

#### CARBON FIBER COLOR OPTIONS

■ Orange Burst	2890624
■ Neon	2890625

ALL MATRYX, ALL AXYS & PRO-RIDE 128 AND LONGER WITH FULL TUNNEL AND LOCK & RIDE FLEX ADAPTER KIT



10-15  
LITERS



### LR FLEX WATERPROOF ROLL TOP BAG

MATRYX AXYS PRO-RIDE



- Our highest level of moisture resistance, built to protect your valuables
- Roll top design allows for quick and easy access

2890008

ALL MATRYX, ALL AXYS & PRO-RIDE 121 AND LONGER WITH FULL TUNNEL AND LOCK & RIDE FLEX ADAPTER KIT

42  
LITERS



22  
LITERS



### LR FLEX NEW ADVENTURE BOX

MATRYX AXYS PRO-RIDE



- Premium hard storage option
- Lock & Ride Flex mounting system
- Latching lid with waterproof seal

2890449

ALL MATRYX, ALL AXYS & PRO-RIDE 128 AND LONGER WITH FULL TUNNEL AND LOCK & RIDE FLEX ADAPTER KIT



MEDIUM

8.5  
LITERS



LARGE

15  
LITERS

### LR FLEX BURANDT BAG

MATRYX AXYS PRO-RIDE

- Compression molded, turtle shell design for enhanced weather resistance
- Oversized buckles provide easy access to gear with your gloves on
- Integrated mounts for spare shovel jacket enabling riders to carry a secondary shovel
- Installation on AXYS and Pro-Ride sleds requires the Lock & Ride Flex Adapter Kit (2884939), sold separately

MEDIUM

Black with zipper closure | 2889258 **★ TOP SELLER**

Liner Bag - Medium | 2889349

#### CARBON FIBER COLOR OPTIONS WITH ROLL TOP LINER

■ Indy Red	2889895
■ Sky Blue	2890631
■ Polaris Blue	2889896
■ Neon	2890632
■ Radiant Green	2890633

ALL MATRYX, ALL AXYS & PRO-RIDE 128 AND LONGER WITH FULL TUNNEL AND LOCK & RIDE FLEX ADAPTER KIT

LARGE

Black with zipper closure | 2889259 **★ TOP SELLER**

Liner Bag - Large | 2889350

#### CARBON FIBER COLOR OPTIONS WITH ROLL TOP LINER

■ Indy Red	2889898
■ Polaris Blue	2889899
■ Neon	2890634

ALL MATRYX 155 AND LONGER, ALL AXYS & PRO-RIDE 155 AND LONGER WITH FULL TUNNEL AND LOCK & RIDE FLEX ADAPTER KIT



SKY BLUE

8.5  
LITERS

### RMK ESSENTIALS BAG

MATRYX

- Lock & Ride Flex storage can be added to the back of the bag
- Bag takes up a small position on the tunnel

Black | 2889257

#### CARBON FIBER COLOR OPTIONS

■ Indy Red	2890621
■ Sky Blue	2890620
■ Neon	2890619

ALL MATRYX RMK



### SPARE SHOVEL JACKET

MATRYX AXYS PRO-RIDE

- Provides a perfect location to bring a secondary shovel on your sled
- Attaches directly to lids of both Medium and Large Lock & Ride Flex Burandt Tunnel Bags
- Riders should always carry their primary shovel in their avalanche backpack

Jacket | 2889322 **★ TOP SELLER**

ALL SNOWMOBILES EQUIPPED WITH A LOCK & RIDE FLEX BURANDT BAG

PIEPS® Shovel T 825 Pro + With Saw Blade | 2883680

ALL SNOWMOBILES



## MATRYX - STORAGE



2.7  
LITERS

### GOGGLE HANDLEBAR BAG

MATRYX AXYS

- Conveniently access spare goggles from the rider's seat

2882823

ALL MATRYX RMK, ALL AXYS RMK



7.6  
LITERS

### GLOVE BOX LINER

MATRYX

- Convenient, organized storage
- Features 4 separate compartments to keep your important items secure
- Compartments seamlessly line the storage area behind your display

2884753 **★ TOP SELLER**

ALL MATRYX



### DASH STORAGE BAG

MATRYX

- 100% waterproof, premium storage bag
- Features waterproof material and zipper access for convenient access and maximum protection of your valuables
- Fits seamlessly into the storage compartment behind your display

2889776 **★ TOP SELLER**

ALL MATRYX



6  
LITERS

### ULTIMATE ADVENTURE SADDLE BAG

MATRYX AXYS PRO-RIDE

- Add even more versatility to the Adventure Rack (2890018) with this saddlebag that can be added to one or both sides of the rack
- Roll top design keeps water out and includes built-in storage pockets to keep smaller items secure
- Features magnetic Fidlock® buckles for easy and secure use in the cold even with gloves on
- Requires the Adventure Rack (2890018), sold separately

2890612

ALL MATRYX 136 AND LONGER, ALL AXYS & PRO-RIDE 136 AND LONGER WITH FULL TUNNEL AND LOCK & RIDE FLEX ADAPTER KIT



47.5  
LITERS

### ADVENTURE RACK BAG

MATRYX AXYS PRO-RIDE

- Keep your gear dry with water resistant material
- Includes 1 large roll top compartment, and 1 small rolltop compartment
- Adjustable organizer with zipper and pockets; additional zipper pockets throughout the bag
- Features magnetic Fidlock® buckles for easy and secure use in the cold even with gloves on
- Requires the Adventure Rack (2890018), sold separately

2890599

ALL MATRYX 136 AND LONGER, ALL AXYS & PRO-RIDE 136 AND LONGER WITH FULL TUNNEL AND LOCK & RIDE FLEX ADAPTER KIT

## MATRYX - HITCHES



### NEW FLAPPER HITCH

- Multi-purpose flapper hitch for light-to-medium towing for hitch & pin connections
- Constructed from high-strength steel
- Hitch attaches with four simple bolts
- Ready for action within minutes

Black | 2891165

ALL MATRYX INDY, SWITCHBACK & VOYAGEUR, ALL AXYS 144



### STANDARD HITCH

Black | 2890690-067

Unpainted | 2882859

ALL MATRYX INDY, SWITCHBACK & VOYAGEUR, ALL AXYS 144



### J-HOOK HITCH

2882915

ALL MATRYX INDY, SWITCHBACK & VOYAGEUR, ALL AXYS 144

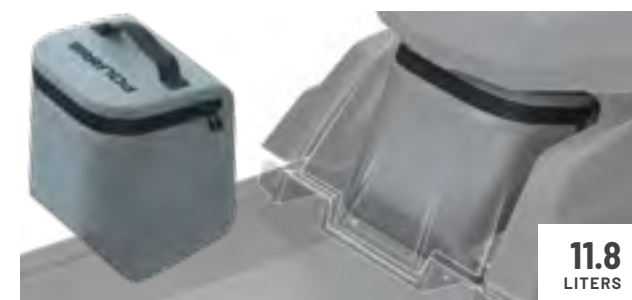

11.8  
LITERS

### UNDERSEAT LINER BAG

MATRYX

- Fits inside factory underseat compartment for waterproof storage

2884752

ALL MATRYX INDY, SWITCHBACK & VOYAGEUR

NOT COMPATIBLE WITH PRO STAR S4 AND BOOST ENGINES WITH ELECTRIC START

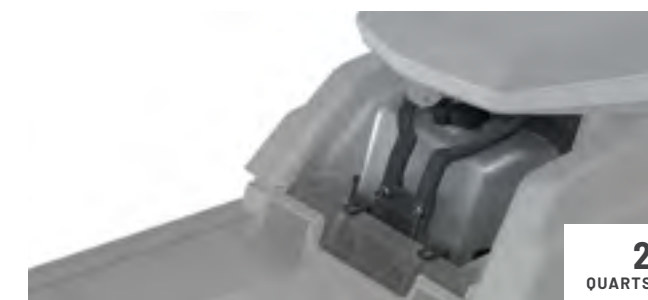

2  
QUARTS

### UNDERSEAT OIL STORAGE

MATRYX

- Safe and reliable method to carry 2 quarts of oil
- Fits underneath the seat on MATRYX trail sleds

2889363

ALL MATRYX INDY, SWITCHBACK & VOYAGEUR

NOT COMPATIBLE WITH PRO STAR S4 AND BOOST ENGINES WITH ELECTRIC START

# LIGHT UP THE NIGHT

When the days just aren't long enough, don't let the dark end your ride early. Maximize your nighttime visibility with our lineup of Auxiliary Lighting options.



SCAN FOR INSTALL VIDEO

## GOOD: STOCK HEADLIGHT



### NIGHTBLADE HEADLIGHT MATRYX

- Most Polaris MATRYX sleds come stock with this state of the art lighting technology
- Six projector beam optics deliver precision lighting with an engineered pattern to deliver exceptional visibility for night riding
- Some models come with a standard LED light instead of the Nightblade. Standard LED lights are also compatible with Auxiliary Lighting Options



### AUXILIARY PUNCH LIGHT MATRYX

- Additional 1,000 lumens per side for increased visibility
- Ride confidently with an increased distance illuminated
- Provides better visibility further down the trail
- Turns on with high beam switch

2889863 ★ TOP SELLER  
ALL MATRYX



### AUXILIARY FLOOD LIGHT MATRYX

- Additional 1,000 lumens per side for increased visibility
- Ride confidently with a wider range of visibility close to your sled
- Provides better visibility to react to your surrounding terrain
- Turns on with high beam switch

2889733 ★ TOP SELLER  
ALL MATRYX



### INTEGRATED CENTER AUXILIARY LIGHT WINDSHIELD MATRYX

- Additional 2,000 lumens for increased visibility
- Ride confidently with an increased illuminated distance
- Turns on with high beam switch
- Comes with windshield - available in three different heights

Tall | 2890510  
Extra Tall | 2890642  
Full Coverage | 2890643  
ALL MATRYX

## BEST: PAIR THEM UP



### AUXILIARY FLOOD LIGHT + INTEGRATED CENTER AUXILIARY LIGHT WINDSHIELD



NIGHTBLADE HIGH BEAM

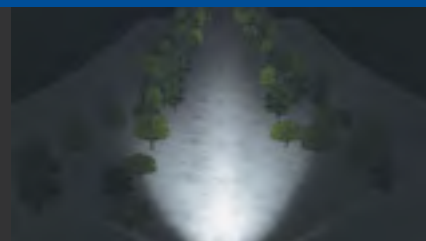

NIGHTBLADE HIGH BEAM + AUXILIARY FLOOD  
Best for wide open spaces & conditions requiring long distance visibility

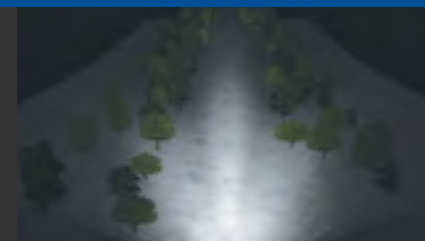

NIGHTBLADE HIGH BEAM + AUXILIARY PUNCH  
Best for tight riding spaces, ditch approaches at night or when you need a broad light

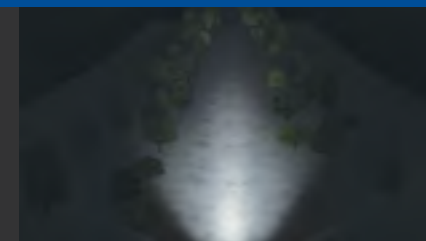

NIGHTBLADE HIGH BEAM + INTEGRATED CENTER AUXILIARY LIGHT WINDSHIELD  
A more focused light pattern down the trail specifically for long distance visibility



NIGHTBLADE HIGH BEAM + AUXILIARY FLOOD + INTEGRATED CENTER AUXILIARY LIGHT WINDSHIELD  
Optimal configuration for maximum visibility

# CUSTOM ACCENT LIGHTS



### GRILL INSERT RGB ACCENT LIGHTS MATRYX

- Add a custom look to your vehicle with lighted grill inserts
- Use the Snow Glow app to select any color
- Easy installation, only 1 wire connector needed with minimal drilling

2890566  
ALL MATRYX

### HANDGUARD RGB ACCENT LIGHTS MATRYX

- Add a custom look to your vehicle with the lighted handguards
- Use the Snow Glow app to select any color
- Easy installation, plug & play solution
- Defend Handguards required, sold separately

2890509  
ALL MATRYX



SCAN TO SHOP LIGHTING

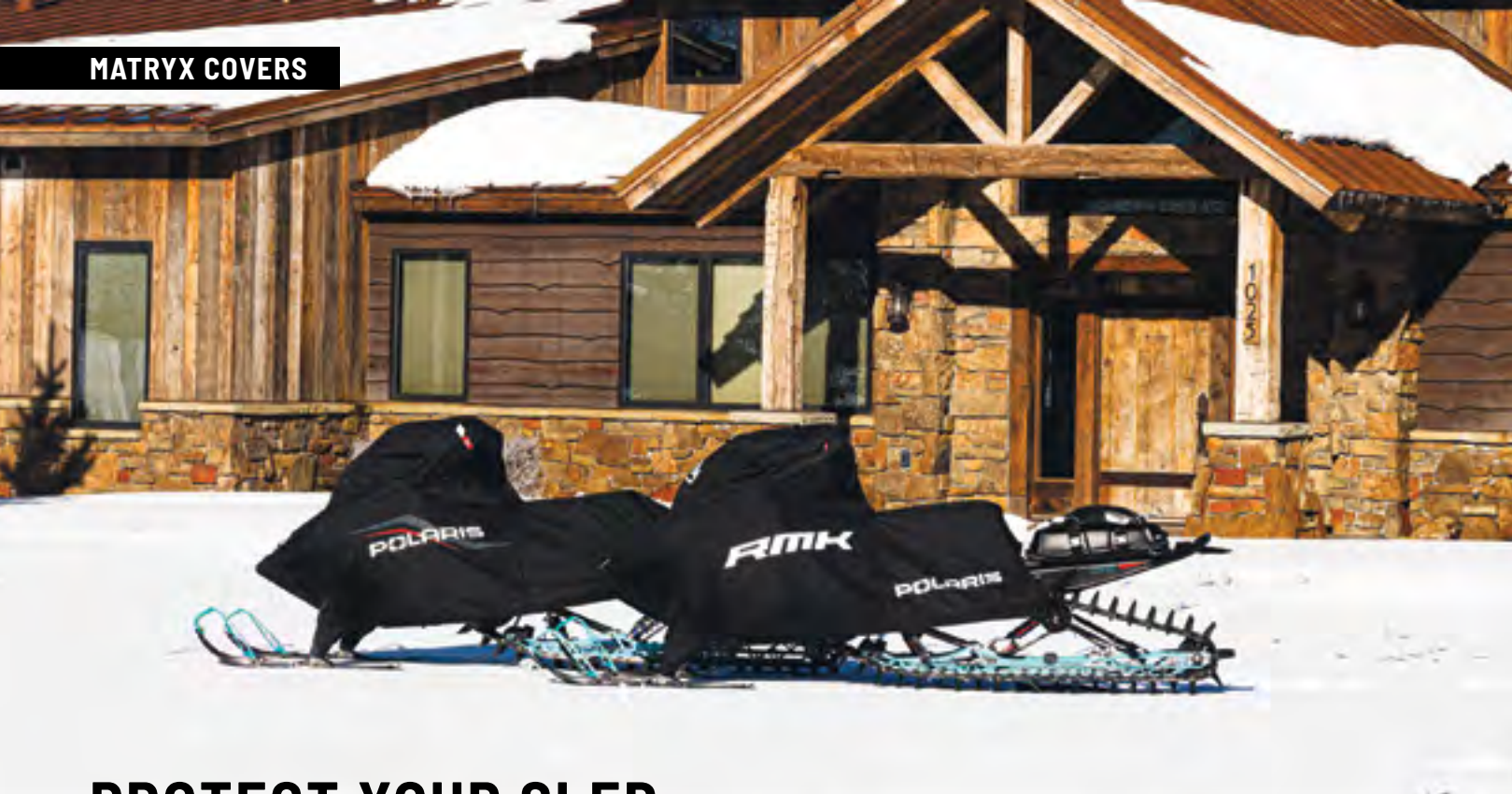

## PROTECT YOUR SLED FROM THE ELEMENTS

### KEEP YOUR SLED LOOKING NEW WITH A POLARIS COVER

- Keep snow and ice off of your sled in between days of riding
- Protect your sled from dirt and slush while trailering
- Protect from harmful UV rays that could fade your coloring over time
- Choose between premium polyester for maximum protection and trailering or the overnight cover for in between rides

## THE POLARIS ADVANTAGE WHY SHOULD YOU CHOOSE A POLARIS COVER?

1. **INTENTIONALLY DESIGNED** for your sled and features easy to use cinch strap technology for a secure hold and perfect fit
2. **PREMIUM MATERIALS** provide advanced protection and lasting durability through the elements
3. **RIDER-CENTRIC FEATURES** such as integrated zippers and straps make Polaris covers easy to use with quick access



### OVERNIGHT/DUST COVER

Lightweight and packable. Ideal for overnight multi-day drops or parking in a shop.



### 3/4 COVER

This cover is ideal for overnight protection, when the sled is stored between rides and during trailering. Designed to fit over all windshield styles and all accessories. Does not cover the tunnel so you still have access to storage & racks.



### FULL COVER

Full sled protection with perfect fitment for your model. Great for towing and off season storage. Zipper access to gas cap, and quick adjust cinch straps and hooks for tightening.



### MATRYX OVERNIGHT COVER MATRYX

- Protects sled from the elements when stored outside overnight
- Made of lightweight polyester that is easy to fold and store
- Ideal for overnight multi-day trips or parked in a shop

2884749  
ALL MATRYX



### MATRYX TRAIL PREMIUM POLYESTER FULL CONVERTIBLE COVER MATRYX

- MATRYX redesigned cinch straps are easier to use and hold secure for a premium fit
- Advanced polyester blend for increased protection
- Convertible Cover: expands and adapts to fit various MATRYX accessory configurations
- Features an integrated rear zipper to accommodate for accessories including seats

Black | 2890074 ★ TOP SELLER

Retro | 2889914

ALL MATRYX INDY, SWITCHBACK & VOYAGEUR

### MATRYX RMK PREMIUM POLYESTER 3/4 COVER MATRYX

- 3/4 design is very easy to put on and take off and works great providing quick access to accessories on the tunnel

2890590  
ALL MATRYX RMK



### MATRYX RMK PREMIUM POLYESTER FULL COVER MATRYX

- Reinforced material added in high impact areas
- New rear strapping system that is much easier to put on and reduces buffeting when trailering
- Improved windshield strap that results in a tighter fit

Full | 2889348 ★ TOP SELLER  
ALL MATRYX RMK



### MATRYX TRAIL PREMIUM POLYESTER 3/4 COVER MATRYX

- 3/4 design is very easy to put on and take off and works great providing quick access to accessories on the tunnel

2890591  
ALL MATRYX INDY, SWITCHBACK & VOYAGEUR



### INDY 120 COVER

- Cover option for youth sled
- Perfect for overnight or trailering

2889890  
ALL 120 SNOWMOBILES



## MATRYX - MOUNTAIN COMFORT



### RMK NARROW HANDLEBARS MATRYX

- ProTaper® handlebars with the same style as the factory handlebars
- Narrow RMK Handlebar has a reduced width (approximately 1.5" narrower)
- Provides better control with precise steering

5" Rise	2891205
6" Rise	2891206
7" Rise	2891207

ALL MATRYX RMK, ALL AXYS RMK



### RMK HANDLEBAR ADJUSTABLE MOUNT MATRYX AXYS

- For the riders who wants to move the handlebars closer or further away from their body.
- Ideal for shorter or taller riders to customize their riding position

2889867  
ALL MATRYX AND AXYS RMK



### RMK BACKCOUNTRY HANDGUARDS MATRYX AXYS

- Provides the ultimate protection for your hands
- Sold in pairs
- Mounts included

Black | 2889868

#### CARBON FIBER COLOR OPTIONS

<span style="color: red;">■</span> Indy Red	2890600
<span style="color: blue;">■</span> Sky Blue	2890601
<span style="color: green;">■</span> Neon	2890602

ALL MATRYX AND AXYS RMK



### RMK DRIVER GAUNTLETS MATRYX

- Keep hands warm and dry in the backcountry with semi-rigid design
- Specifically designed for the most extreme level of backcountry riding
- Remove or add on the fly with an allen wrench

2890603  
ALL MATRYX RMK



2890665



2890667

### ULTIMATE KNEE PADS MATRYX

- One pair of knee pads
- Provides protection to knees from bumps against the console
- High quality, durable foam construction for lasting quality

	RMK	INDY SWITCHBACK
<span style="color: gray;">■</span> Steel Gray <small>★ TOP SELLER</small>	2889944	2889889
<span style="color: black;">■</span> Premium Black* <small>★ TOP SELLER</small>	2890666	2890669
<span style="color: blue;">■</span> Sky Blue	2890665	2890668
<span style="color: green;">■</span> Neon	2890664	2890667

ALL MATRYX  
\*PREMIUM BLACK KNEE PADS HAVE EXTRA PADDING, SOFTER FOR EXTRA COMFORT



## MATRYX - TRAIL COMFORT

### TRAIL HEATED DRIVER SEAT MATRYX

- Features easy-to-use high/low/off switch for complete control
- Complete seat assembly with all mounting hardware and harness included

2891077  
ALL MATRYX INDY, SWITCHBACK & VOYAGEUR

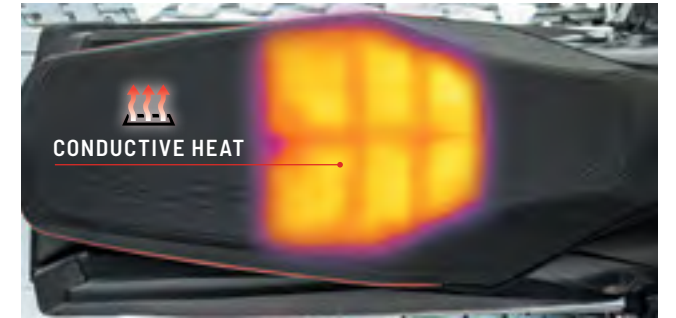

### TRAIL HANDLEBAR PAD MATRYX AXYS

- Complete the look of your handlebars with the seamlessly integrated Handlebar Pad
- Provides additional padding and protection on handlebars
- Built in storage compartment to fit your essentials
- Does not work with Defend Handguards

Indy and Switchback | 2890614  
ALL MATRYX INDY & SWITCHBACK  
FITS MATRYX VOYAGEUR WITH RISER BAR HOOP REMOVED



### INSIGHT SIDE MIRRORS MATRYX

- Keep an eye on what's behind you and ride ahead with confidence
- Side-panel mount allows for use of handguards or gauntlets

2890103  
ALL MATRYX INDY, SWITCHBACK & VOYAGEUR



### DEFEND HANDGUARDS MATRYX

- Oversized design offers increased protection and warmth; factory-color-matched

<span style="color: black;">■</span> Gloss Black	2884616-266
<span style="color: red;">■</span> Indy Red	2884616-293
<span style="color: white;">■</span> White	2884616-599

ALL MATRYX, NOT COMPATIBLE WITH XL ADJUSTABLE, EXTRA TALL OR FULL COVERAGE WINDSHIELDS  
REQUIRES DEFEND HANDGUARD MOUNTS, SOLD SEPARATELY



### DEFEND HANDGUARD SIGNATURE LIGHT MATRYX

- Elevated customization with signature accent lighting for handguards

2884933  
ALL MATRYX  
REQUIRES DEFEND HANDGUARDS & DEFEND HANDGUARD MOUNTS, EACH SOLD SEPARATELY

### DEFEND HANDGUARD MOUNTS MATRYX

- Made of durable and strong, yet flexible injection molded plastic
- Mounts are required to install Defend Handguards

2889305  
ALL MATRYX RMK  
2884617  
ALL MATRYX INDY, SWITCHBACK & VOYAGEUR

### HANDGUARD RGB ACCENT LIGHTS MATRYX

2890509  
ALL MATRYX  
DEFEND HANDGUARDS & DEFEND HANDGUARD MOUNTS REQUIRED, EACH SOLD SEPARATELY. SEE P. 18 FOR MORE DETAILS



# FIND THE RIGHT WINDSHIELD FOR YOU

Easily modify to your desired level of wind protection with the adjustable windshield, or find the right windshield built for the type of riding you do most.

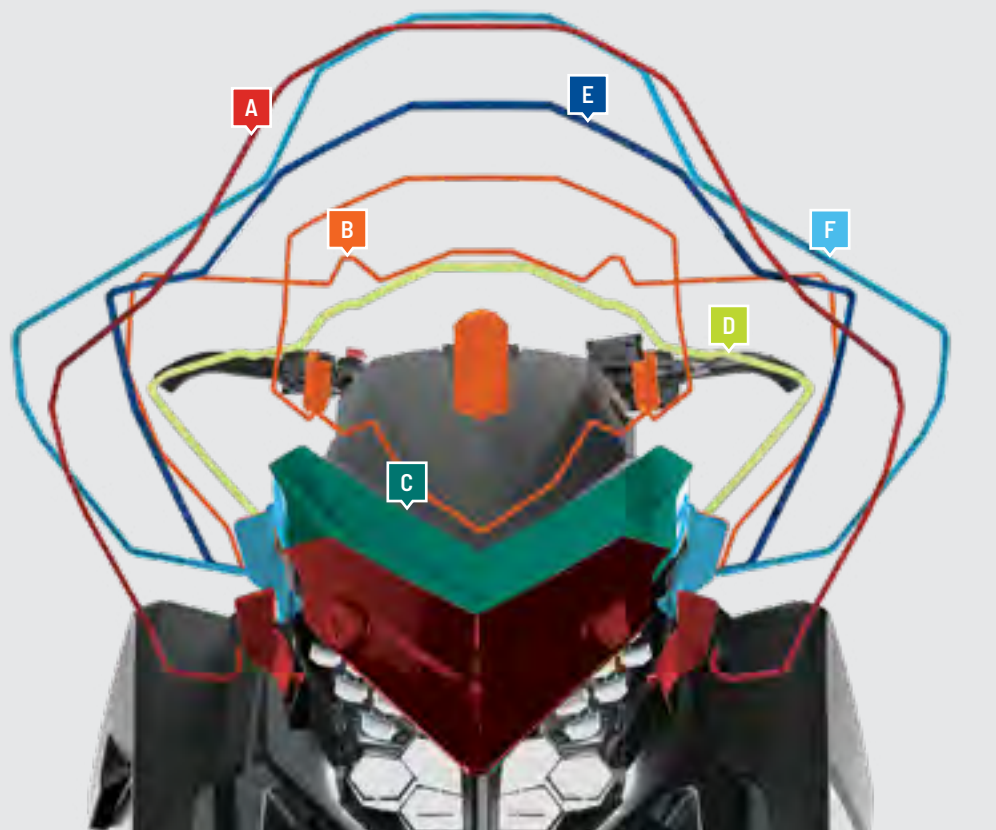

**A**  
29"  
TALL

## ALASKAN WINDSHIELD MATRYX

✕ Clear 2890350

ALL MATRYX



**E**  
23"-27"  
TALL

## EXTRA LARGE ADJUSTABLE WINDSHIELD MATRYX

✕ Clear 2889865

ALL MATRYX, NOT COMPATIBLE WITH HANDGUARDS

**B**  
20"-24"  
TALL

## ADJUSTABLE WINDSHIELD MATRYX

✕ Clear 2889255

ALL MATRYX



**C**



**D**  
15"  
TALL

## BEZEL MATRYX

■ Gloss Black	2884936-266
■ Indy Red	2884936-293
■ Orange Burst	2884936-647
■ Sky Blue	2884936-737
■ Polaris Blue	2884936-751
■ Plum Crazy	2884936-784
■ Neon	2884936-801

ALL MATRYX

## DEEP SNOW LOW WINDSHIELD MATRYX

■ Dark Smoke 2889405

ALL MATRYX



**E**  
20"  
TALL

## \* TOP SELLER MID WINDSHIELD MATRYX

■ Dark Smoke 2884934

ALL MATRYX

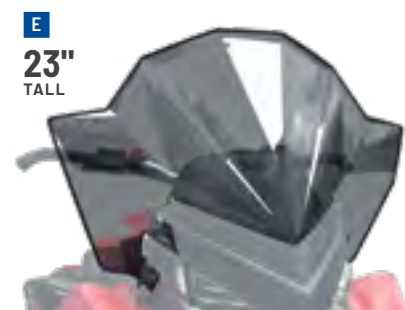

**E**  
23"  
TALL

## \* TOP SELLER TALL WINDSHIELD MATRYX

■ Smoke 2884935

ALL MATRYX, COMPATIBLE WITH HANDGUARDS WITH HANDLEBAR POSITION ADJUSTMENT



**E**  
24"  
TALL

## EXTRA TALL WINDSHIELD MATRYX

✕ Clear 2885128

✕ Clear with Polaris Graphic 2889202

ALL MATRYX, NOT COMPATIBLE WITH HANDGUARDS

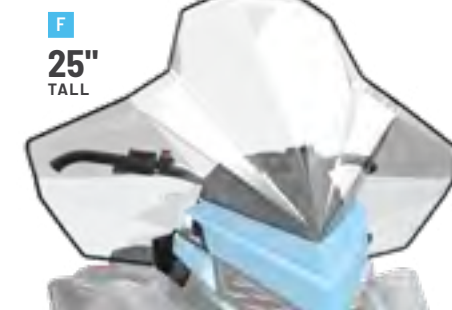

**F**  
25"  
TALL

## FULL COVERAGE WINDSHIELD MATRYX

✕ Clear 2889256

ALL MATRYX, NOT COMPATIBLE WITH HANDGUARDS



## MATRYX – SEATING



### LR FLEX M2 SEAT MATRYX ★ TOP SELLER

- All-in-one passenger seating system in standard or heated version
- Both versions come with heated grips
- Heated M2 Seat adds additional comfort for your passenger by adding a heating element to the base of the seat
- Not compatible with Lock & Ride Flex Adapter Kit
- Suspension adjustment required for optimal 2-up riding performance

Standard | 2884725  
Heated | 2884957  
ALL MATRYX INDY, SWITCHBACK & VOYAGEUR



### M2 PASSENGER GAUNTLETS MATRYX

- Passenger gauntlets for the M2 Seat
- Made from compression molded nylon
- Utilizes faux fur lining to provide additional warmth to the passenger's hands

2889364  
ALL MATRYX INDY, SWITCHBACK & VOYAGEUR, REQUIRES M2 PASSENGER SEAT (2884725 OR 2884957), SOLD SEPARATELY

### PASSENGER FOOTREST MATRYX

- Rugged extruded aluminum design adds passenger comfort

2884813-067  
ALL MATRYX INDY, SWITCHBACK & VOYAGEUR

### M2 SEAT STORAGE BAG MATRYX

- Semi-rigid design fits securely beneath accessory M2 seat leaving room for additional tunnel storage

2884956  
ALL MATRYX INDY, SWITCHBACK & VOYAGEUR, REQUIRES M2 PASSENGER SEAT (2884725 OR 2884957), SOLD SEPARATELY

### REAR TORSION SPRING KITS MATRYX AXYS

CUSTOMIZE YOUR RIDE BASED ON TOTAL RIDER WEIGHT  
(COMBINED WEIGHT OF RIDER, GEAR AND/OR PASSENGER)

Part Number	Weight Range
2884973	129/137 Light Duty
2884974 ★ TOP SELLER	129/137 Heavy Duty
2884975	129/137 Extra Heavy Duty

ALL MATRYX/AXYS 129 & 137

2884976	144/146 Light Duty
2884977	144/146 Heavy Duty

ALL MATRYX SWITCHBACK ASSAULT, XC, AND SP,  
AXYS SWITCHBACK ASSAULT 144

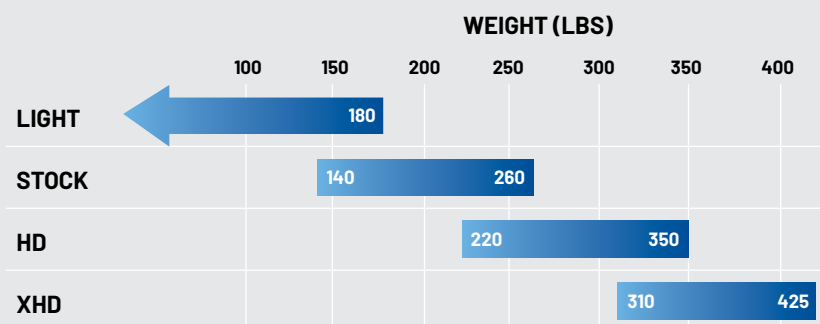

### LR FLEX TRAIL JUMP SEAT MATRYX

- Seamless, lightweight passenger seat to use when you need it
- Lock & Ride Flex enabled for easy on and off, or leave it on all season with no impact on performance or feel
- Ergonomic side handles for extra grip

2890496  
ALL MATRYX INDY, SWITCHBACK & VOYAGEUR



### TRAIL HEATED DRIVER SEAT MATRYX

- Features easy-to-use high/low/off switch for complete control
- Complete seat assembly with all mounting hardware and harness included

2891077  
ALL MATRYX INDY, SWITCHBACK & VOYAGEUR

ACCESSORIES

LOCK & RIDE FLEX

POLARIS PARTNERS

CONNECTED TECHNOLOGY

MATRYX

AXYS

PRO-RIDE

RIDE READINESS

COLOR CUSTOMIZATION

TRANSPORT

TRACTION & CONTROL

TRACKS



★ TOP SELLER  
**GRILL INSERTS** MATRIX

- Provides enhanced, custom style to your sled
- Custom painted and color matched for optimal styling

■ Gloss Black	2884979-067
■ Indy Red	2884979-293
■ Orange Burst	2884979-647
■ Sky Blue	2884979-737
■ Polaris Blue	2884979-751
■ Plum Crazy	2884979-784
■ Neon	2884979-801
■ Stealth Gray	2884979-804
■ Radiant Green	2884979-887

ALL MATRIX

**GRILL INSERT RGB ACCENT LIGHTS** MATRIX

- Add a custom look to your vehicle with lighted grill inserts
- Use the Snow Glow app to select any color
- Easy installation, only 1 wire connector needed with minimal drilling

2890566

ALL MATRIX



★ TOP SELLER  
**SENTRY SKID PLATE** MATRIX

- Protect your sled from unexpected obstacles with this skid plate
- Rugged, custom design fits perfectly to the underside of your sled, dramatically increasing impact resistance and letting you ride ahead with confidence
- Color-matched custom style to compliment the look of your machine
- Installs easily and quickly
- Constructed from tough, durable UHMW plastic
- Includes all mounting hardware

■ Black	2884816-070
■ Bright White	2884816-133
■ Indy Red	2884816-293
■ Polaris Blue	2884816-751
■ Neon	2884816-801

ALL MATRIX



★ TOP SELLER  
**SENTRY FRONT BUMPER** MATRIX

- Engineered for a custom fit to align with the overall design of your sled
- Features color-matched style, so you don't compromise looks for utility

■ Gloss Black	2884817-067
■ Bright White	2884817-133
■ Indy Red	2884817-293
■ Turbo Silver	2884817-402
■ Orange Burst	2884817-647
■ Sky Blue	2884817-737
■ Polaris Blue	2884817-751
■ Plum Crazy	2884817-784
■ Neon	2884817-801
■ Stealth Gray	2884817-804
■ Radiant Green	2884817-887

ALL MATRIX



**SENTRY TRAIL REAR BUMPER** MATRIX AXYS

- Equip yourself for any condition and any trail with this Rear Bumper
- Made from High Grade Aluminum, this bumper stands up to the roughest trails
- Available in a variety of powder-coated colors to match the overall style of your sled
- Rear grab bar is easy to use with gloved hands

■ Gloss Black	2884257-067
■ Bright White	2884257-133
■ Indy Red	2884257-293
■ Turbo Silver	2884257-402
■ Orange Burst	2884257-647
■ Velocity Blue	2884257-689
■ Sky Blue	2884257-737
■ Polaris Blue	2884257-751
■ Stealth Gray	2884257-804

ALL AXYS 129, 137 AND 144/146 SWITCHBACK,  
ALL MATRIX INDY, SWITCHBACK & VOYAGEUR

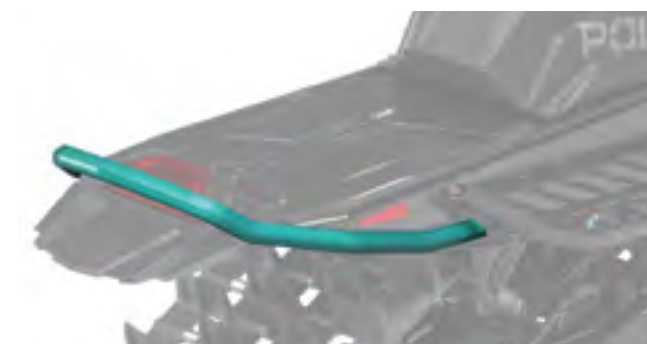

**SENTRY MOUNTAIN REAR BUMPER** MATRIX

- Add a custom look and great protection to your sled
- Comes stock and in a variety of colors on RMK sleds
- The rear grab bar is easy to use with gloved hands

	146"	155"	155"/163"/165"
■ Gloss Black*	2889351-067	2889352-067	2889353-067
■ Indy Red	2889351-293	2889352-293	2889353-293
■ Turbo Silver	2889351-402	2889352-402	2889353-402
■ Orange Burst	2889351-647	2889352-647	2889353-647
■ Sky Blue	2889351-737	2889352-737	2889353-737
■ Polaris Blue	2889351-751	2889352-751	2889353-751
■ Plum Crazy	2889351-784	2889352-784	2889353-784
■ Neon	2889351-801	2889352-801	2889353-801
■ Stealth Gray	2889351-804	2889352-804	2889353-804
■ Radiant Green	2889351-887	2889352-887	2889353-887

146" FITMENT: ALL MATRIX RMK KHAOS 146  
155" FITMENT: ALL MATRIX RMK 155  
155"/163"/165" FITMENT: ALL MATRIX RMK 155/163/165 AND 163/165  
\*STOCK REAR BUMPER ON ALL MATRIX RMK MODELS



**NEW**  
BURANDT FLOAT 3 QS  
LIGHTWEIGHT SERIES MATRYX

- Burandt specific calibration
- Optimized lightweight shock design
- One-piece, aluminum spherical bearings
- High-flow velocity-sensitive damping
- Internal groove position sensitive technology
- Fully rebuildable and re-tuneable

2891219  
RMK KHAOS FLOAT TRACK REAR  
2891221  
PRO RMK FLOAT TRACK REAR

2891291  
FLOAT FRONT



**NEW**  
BURANDT 1.5 ZERO QS  
LIGHTWEIGHT SERIES MATRYX

- Burandt specific calibration
- Optimized lightweight spring and shock design
- FOX® ice scraper technology (FIST)
- One-piece, aluminum mounting hardware
- High-flow velocity-sensitive damping
- Internal groove position sensitive technology
- Fully rebuildable and re-tuneable

2891220  
RMK KHAOS ZERO TRACK REAR  
2891222  
PRO RMK ZERO TRACK REAR

2891292  
ZERO FRONT



**NXT LVL FRONT BUMPER** MATRYX

- Bumper incorporates a front bash plate that wraps under the front of the chassis
- The bash plate secures to the bulkhead just behind the a-arm front mounts
- Constructed of super strong lightweight aluminum
- Features a powder-coated finish with full OEM color match
- Easy installation



**NXT LVL REAR BUMPER** MATRYX

- Premium rear bumper for added protection
- Increased tunnel rigidity
- Raised rear grab bar is easy to use with gloved hands
- Lightweight, super strong aluminum construction
- Features a powder-coated finish with full OEM color match
- Easy installation utilizing OEM mount holes

	FRONT	REAR 146"	REAR 155"	REAR 163"/165"
■ Army Green	NXPFB230AG	NXPRB231AG	NXPRB234AG	NXPRB232AG
■ Black	NXPFB230-BLK	NXPRB231-BLK	NXPRB234-BLK	NXPRB232-BLK
■ Neon	NXPFB230LL	NXPRB231LL	NXPRB234LL	NXPRB232LL
■ Matte Black	NXPFB230-FBK	NXPRB231-FBK	NXPRB234-FBK	NXPRB232-FBK
■ Military Tan	NXPFB230MT	NXPRB231MT	NXPRB234MT	NXPRB232MT
■ Orange	NXPFB230-ORG	NXPRB231-ORG	NXPRB234-ORG	NXPRB232-ORG
■ Polaris Blue	NXPFB230-PBL	NXPRB231-PBL	NXPRB234-PBL	NXPRB232-PBL
■ Plum Crazy Purple	NXPFB230-PCP	NXPRB231-PCP	NXPRB234-PCP	NXPRB232-PCP
■ Red	NXPFB230-RD	NXPRB231-RD	NXPRB234-RD	NXPRB232-RD
■ Radiant Green	NXPFB230RG	NXPRB231RG	NXPRB234RG	NXPRB232RG
■ Sky Blue	NXPFB230-SBL	NXPRB231-SBL	NXPRB234-SBL	NXPRB232-SBL
■ White	NXPFB230-WHT	NXPRB231-WHT	NXPRB234-WHT	NXPRB232-WHT
■ Zenith Blue	NXPFB230ZB	NXPRB231ZB	NXPRB234ZB	NXPRB232ZB
	FRONT: ALL MATRYX	REAR 146" FITMENT: MATRYX RMK 146 SLASH REAR 155" FITMENT: MATRYX RMK 155 SLASH REAR 163" FITMENT: MATRYX RMK 165 SLASH & 165 STANDARD		



## MATRYX TITAN - PROTECTION



### NEW HD FRONT BUMPER

MATRYX TITAN

- Rugged, heavy-duty wrap-around bumper with integrated front-facing winch mount
- Able to withstand the forces of the winch pulling to get your sled unstuck
- Provides as much protection as possible to your sled
- Easy installation

2890372  
MATRYX TITAN



### NEW RUNNING BOARD CLOSEOFF

MATRYX TITAN

- Helps keep your running boards free of snow and ice build-up
- A clear running board free from ice and slush means better traction and control

2890611  
MATRYX TITAN



### NEW KNEE PADS

MATRYX TITAN

- Provides protection to knees from bumps against the console
- High quality, durable foam construction for long lasting quality
- Have a more comfortable riding experience with these high quality knee pads

2890341  
MATRYX TITAN

## MATRYX TITAN - COMFORT & CONVENIENCE



### NEW MATRYX TITAN HEATED DRIVER SEAT

MATRYX TITAN

- Integrated heating element
- Stay warm even in the coldest of temperatures
- All necessary mounting hardware and installation harness is included

2891074  
MATRYX TITAN



### NEW UTILITY MIRRORS

MATRYX TITAN

- Offers additional visibility to your sled
- Mounts to the Titan console
- Sold in pairs

2890640  
MATRYX TITAN



### NEW TRAILER COVER

MATRYX TITAN

- Trailer cover that withstands high speeds and salt while trailering
- UV resistant Poly material
- Keeps snow and dust off your sled
- Offers full sled protection

2890351  
MATRYX TITAN



### NEW OVERNIGHT COVER

MATRYX TITAN

- Lightweight and compactable (rolls down)
- Keeps snow/dust off the sled
- UV protection from sun fading

2890352  
MATRYX TITAN

ACCESSORIES

LOCK & RIDE  
FLEX

POLARIS  
PARTNERS

CONNECTED  
TECHNOLOGY

MATRYX

AXYS

PRO-RIDE

RIDE  
READINESS

COLOR  
CUSTOMIZATION

TRANSPORT

TRACTION  
& CONTROL

TRACKS



**NEW**  
ELECTRIC CHAINSAW MOUNT MATRYX TITAN

- Easy to install on the rear Titan rack
- Does not prohibit storage box usage
- Provides secure transportation of most chainsaw lengths
- Perfect chainsaw carrying solution for work outings

2890342  
MATRYX TITAN



**NEW**  
HUB HOUSE CARRIER MATRYX TITAN

- Carry a pop-up shelter directly on your Titan sled
- Integrates into the Titan rack for easy installation

2890344  
MATRYX TITAN



**NEW**  
BOGIE WHEEL KIT MATRYX TITAN

- Be prepared for less than ideal snow conditions
- Avoid overheating or excessive hyfax wear when snow conditions are minimal
- Perfect for early and late season riding

2891040  
MATRYX TITAN



**NEW**  
TOOL CARRIER MATRYX TITAN

- Integrated attachment system for the new Titan utility portfolio
- Designed specifically for Matryx Titan
- Enables attachment of Electric Ice Auger Mount, Hub House Carrier and Electric Chainsaw Mount

2890349  
MATRYX TITAN



**NEW**  
ELECTRIC ICE AUGER MOUNT MATRYX TITAN

- Premium rack securely holds your ice auger for easy transport
- Mounts on either side of the Titan rack for safe snowmobile operation
- Doesn't prohibit storage box usage
- Don't worry about operation or storage restraints with this electric ice auger transport

2890348  
MATRYX TITAN



**NEW**  
MATRYX TITAN WINCH KIT MATRYX TITAN

- Versatile and rugged, perfect to clear downed trees or retrieve a stuck snowmobile
- Powerful 1,500 lbs. towing capacity
- Includes winch, mount, cables and wireless winch remote
- Mounts to rear of sled

2891169  
MATRYX TITAN

# Otter®

With Otter® and Polaris your ice-fishing trips just got transformed. It's about the thrill of exploration, the comfort of shared laughter, and the satisfaction of landing that trophy catch. So grab your gear and create unforgettable ice-fishing memories!



### ADVENTURE TRAILER

- Add to the Otter® Pro Sled, required, sold separately, or any other compatible utility sled for a smoother towing experience to reduce drag and snow intrusion inside of sled
- 44" W with adjustable base length to use with a variety of utility sleds (up to 85" L)
- Features elevated base with integrated suspension and ski's
- Powered tail light with integrated bumper for visibility (electrical trailer harness included; electrical sled harness required, sold separately - 2890698 Matryx Indy and Switchback, 2890699 Axys Titan Adventure, 2890700 Universal Fitment)
- Hitch required, sold separately

2890066  
ALL SNOWMOBILES



LARGE

### OTTER® PRO SLED

- Available in 3 different sizes depending on your cargo carrying needs
- Securely transport all your cargo with raised edges to resist snow intrusion and keep your gear in place
- Extreme weather performance and unmatched pulling strength with reinforced outer lip, in-mold hitch pockets and high performance bottom ribs
- Add the Adventure Trailer (2890066), sold separately, to enhance your towing experience

Medium (65" L x 32" W x 15" H) | 2890659  
Magnum (75" L x 38" W x 15" H) | 2890661  
Large (85" L x 44" W x 17" H) | 2890660  
ALL SNOWMOBILES



STANDARD

### OTTER® TOW HITCH

- Fits the Small, Medium & Magnum Sleds
- Easy convenient option to tow your Otter® Shelter or Sled
- Heavy duty steel tubing
- Baked-on finish offers incredible strength & durability
- Spring loaded coupler to absorb shocks and pivots during travel

Standard | 2890891  
FITS SMALL, MEDIUM AND MAGNUM SLEDS  
Large | 2890892  
FITS LARGE SLEDS



MEDIUM

### OTTER® COVER

- Made for the Otter® Pro Sled Medium
- Protect the gear you're towing during transport
- Heavyweight polyester fabric is extremely durable
- Water resistant cover
- Sewn in shock cord is perfect to keep out snow, mud and slush

Medium | 2890885  
Magnum | 2890887  
Large | 2890886  
ALL SNOWMOBILES



MEDIUM

### OTTER® HYFAX SLED RUNNER KIT

- Multiple sizes available
- Protect the bottom of your Otter® Shelter
- Adds extreme durability for long hauls
- 5/8" thick, high density plastic runners
- Bolts into sleds Roto-Molded pockets
- Works on Otter® Pro Sleds

Medium | 2890888  
Magnum | 2890890  
Large | 2890889  
ALL SNOWMOBILES



48" DEEP

### OTTER® PRO-TECH ROD CASE

- Comes in 4 different sizes to accommodate various pole types
- Bring along all your tackle with cutouts for tackle storage boxes
- Extremely durable with double wall roto-molded construction, high strength nylon handles, nickel plated steel hardware, and polyurethane foam for added protection
- Securely transport and easily access your gear with Ultra-Lock Quick Release Latches

40" Deep | 2890655  
40" Regular | 2890656  
48" Deep | 2890657  
48" Regular | 2890658  
ALL SNOWMOBILES



# AXYS

The proven AXYS platform delivers rider-balanced control and unrivaled acceleration. Our comprehensive collection of accessories includes everything needed to customize your sled's style, storage, comfort and protection to truly make it your own.

## RMK

2020-2022 AXYS KHAOS  
2016-2022 AXYS PRO RMK  
2016-2021 SKS  
2016-2019 ASSAULT

## INDY

2020-2021 ADVENTURE/XC 137  
2020-2021 XCR  
2019-2021 XC 129

## VOYAGEUR

2017-2021 600

## SWITCHBACK

2017-2021 ASSAULT  
2015-2021 PRO-S/PRO-X/XCR  
2017-2019 SP

## RUSH

2015-2020 RUSH

## TITAN

2025 PROSTAR S4 ADVENTURE  
2018-2024 ADVENTURE  
2018-2022 XC  
2018-2021 SP

### AXYS - STORAGE



RETROFIT YOUR SLED WITH **LR FLEX**

Unlock a world of quick-swap storage, racks, and gear that adapts to your every adventure. From powder days to weekend getaways, transform your snowmobile on the fly and experience the freedom of endless possibilities.



#### LOCK & RIDE FLEX ADAPTER KIT **AXYS** **PRO-RIDE**

• Add Lock & Ride Flex storage to AXYS and Pro-Ride full tunnel sleds

**2884939** **★ TOP SELLER**

ALL PRO-RIDE & AXYS SLEDS W/ TUNNEL T-SLOTS,  
NOT COMPATIBLE WITH LOCK & RIDE FLEX M2 SEAT



#### **LR FLEX** SPORT TUNNEL BAG **MATRYX** **AXYS** **PRO-RIDE**

Low | **2884453**  
ALL MATRYX, ALL AXYS & PRO-RIDE 121 AND LONGER WITH FULL TUNNEL AND LOCK & RIDE FLEX ADAPTER KIT

Liner Bag - Small  
**2889260**

Tall | **2884454** **★ TOP SELLER**  
ALL MATRYX, ALL AXYS & PRO-RIDE 121 AND LONGER WITH FULL TUNNEL AND LOCK & RIDE FLEX ADAPTER KIT

Liner Bag - Large  
**2889261**



#### **LR FLEX** WATERPROOF ROLL TOP BAG **MATRYX** **AXYS** **PRO-RIDE**

• Our highest level of moisture resistance, built to protect your valuables  
• Roll top design allows for quick and easy access

**2890008**

ALL MATRYX, ALL AXYS & PRO-RIDE 121 AND LONGER WITH FULL TUNNEL AND LOCK & RIDE FLEX ADAPTER KIT

## AXYS - STORAGE



### LR FLEX ADVENTURE TUNNEL BAG

**LOW**  
Black | 2884455 **★ TOP SELLER**  
Liner Bag - Small | 2889262

**TALL**  
Black | 2884456 **★ TOP SELLER**  
Liner Bag - Large | 2889263



### LR FLEX BURANDT BAG

• Compression molded, turtle shell design for enhanced weather resistance  
• Oversized buckles provide easy access to gear with your gloves on

• Integrated mounts for spare shovel jacket enabling riders to carry a secondary shovel  
• Installation on AXYS and Pro-Ride sleds requires the Lock & Ride Flex Adapter Kit (2884939), sold separately

**MEDIUM**  
Black with zipper closure | 2889258 **★ TOP SELLER**  
Liner Bag - Medium | 2889349

#### CARBON FIBER COLOR OPTIONS WITH ROLL TOP LINER

Indy Red	2889895
Sky Blue	2890631
Polaris Blue	2889896
Neon	2890632
Radiant Green	2890633

ALL MATRYX, ALL AXYS & PRO-RIDE 128 AND LONGER WITH FULL TUNNEL AND LOCK & RIDE FLEX ADAPTER KIT

**LARGE**  
Black with zipper closure | 2889259 **★ TOP SELLER**  
Liner Bag - Large | 2889350

#### CARBON FIBER COLOR OPTIONS WITH ROLL TOP LINER

Indy Red	2889898
Polaris Blue	2889899
Neon	2890634

ALL MATRYX 155 AND LONGER, ALL AXYS & PRO-RIDE 155 AND LONGER WITH FULL TUNNEL AND LOCK & RIDE FLEX ADAPTER KIT



#### LOW CARBON FIBER COLOR OPTIONS

Sky Blue	2890622
Neon	2890623

ALL MATRYX, ALL AXYS & PRO-RIDE 128 AND LONGER WITH FULL TUNNEL AND LOCK & RIDE FLEX ADAPTER KIT

#### TALL CARBON FIBER COLOR OPTIONS

Orange Burst	2890624
Neon	2890625

ALL MATRYX, ALL AXYS & PRO-RIDE 128 AND LONGER WITH FULL TUNNEL AND LOCK & RIDE FLEX ADAPTER KIT



### SPARE SHOVEL JACKET

• Provides a perfect location to bring a secondary shovel on your sled  
• Attaches directly to lids of both Small and Large Lock & Ride Flex Burandt Tunnel Bags

Jacket | 2889322 **★ TOP SELLER**

ALL SNOWMOBILES EQUIPPED WITH A LOCK & RIDE FLEX BURANDT BAG  
PIEPS® Shovel T 825 Pro + With Saw Blade | 2883680  
ALL SNOWMOBILES



### LR FLEX NEW ADVENTURE BOX

• Premium hard storage option  
• Lock & Ride Flex mounting system  
• Latching lid with waterproof seal

2890449

ALL MATRYX, ALL AXYS & PRO-RIDE 128 AND LONGER WITH FULL TUNNEL AND LOCK & RIDE FLEX ADAPTER KIT



### LR FLEX LOCK & RIDE FLEX ADVENTURE RACK

• Get more out of your ride with the versatility of the Adventure Rack  
• Lock & Ride Flex bags work within the rack

2890018

ALL MATRYX 136 AND LONGER, ALL AXYS & PRO-RIDE 136 AND LONGER WITH FULL TUNNEL AND LOCK & RIDE FLEX ADAPTER KIT



### ADVENTURE RACK BAG

• Keep your gear dry with water resistant material  
• Includes 1 large roll top compartment, and 1 small rolltop compartment  
• Adjustable organizer with zipper and pockets; additional zipper pockets throughout the bag  
• Features magnetic Fidlock® buckles for easy and secure use in the cold even with gloves on  
• Adventure Rack (2890018) required, sold separately

2890599

ALL MATRYX 136 AND LONGER, ALL AXYS & PRO-RIDE 136 AND LONGER WITH FULL TUNNEL AND LOCK & RIDE FLEX ADAPTER KIT



### ULTIMATE ADVENTURE SADDLE BAG

• Add even more versatility to the Adventure Rack (2890018) with this saddlebag that can be added to one or both sides of the rack  
• Roll top design keeps water out and includes built-in storage pockets to keep smaller items secure  
• Features magnetic Fidlock® buckles for easy and secure use in the cold even with gloves on  
• Adventure Rack (2890018) required, sold separately

2890612

ALL MATRYX 136 AND LONGER, ALL AXYS & PRO-RIDE 136 AND LONGER WITH FULL TUNNEL AND LOCK & RIDE FLEX ADAPTER KIT



ACCESSORIES

LOCK & RIDE FLEX

POLARIS PARTNERS

CONNECTED TECHNOLOGY

MATRYX

AXYS

PRO-RIDE

RISE READINESS

COLOR CUSTOMIZATION

TRANSPORT

TRACTION & CONTROL

TRACKS

## AXYS - STORAGE & RACKS



4 LITERS

5 LITERS

### WINDSHIELD BAG AXYS

- Bag installs inside base of windshield using stock push-dart fasteners
- Compression-molded semi-rigid material
- Engine heat warms/dries goggles and gloves

**A** Low Pro | 2880481  
Large | 2880374  
ALL AXYS



9.8 LITERS

### MOUNTAIN DASH BAG AXYS

- Convenient storage for two bottles of water, goggles, gloves, or anything else you need easy access to

**B** 2880375  
AXYS PRO-RMK, SKS 155, RMK ASSAULT



2.7 LITERS

### GOGGLE HANDLEBAR BAG MATRYX AXYS

- Conveniently access spare goggles from the driver's seat

**C** 2882823  
ALL MATRYX, ALL AXYS



### ADVENTURE TRAILER MATRYX AXYS PRO-RIDE

- Add to the Otter® Pro Sled, required, sold separately, or any other compatible utility sled for a smoother towing experience to reduce drag and snow intrusion inside of sled
- 44" W with adjustable base length to use with a variety of utility sleds (up to 85" L)
- Features elevated base with integrated suspension and ski's
- Powered tail light with integrated bumper for visibility (electrical trailer harness included; electrical sled harness required, sold separately - 2890698 Matryx Indy and Switchback, 2890699 Axys Titan Adventure, 2890700 Universal Fitment)
- Hitch required, sold separately

2890066  
ALL SNOWMOBILES



LARGE

### OTTER® PRO SLED MATRYX AXYS PRO-RIDE

- Available in 3 different sizes depending on your cargo carrying needs
- Securely transport all your cargo with raised edges to resist snow intrusion and keep your gear in place
- Extreme weather performance and unmatched pulling strength with reinforced outer lip, in-mold hitch pockets and high performance bottom ribs
- Add the Adventure Trailer (2890066), sold separately, to enhance your towing experience

Medium (65" L x 32" W x 15" H) | 2890659  
Magnum (75" L x 38" W x 15" H) | 2890661  
Large (85" L x 44" W x 17" H) | 2890660  
ALL SNOWMOBILES



48" DEEP

### OTTER® PRO-TECH ROD CASE MATRYX AXYS PRO-RIDE

- Comes in 4 different sizes to accommodate various pole types
- Bring along all your tackle with cutouts for tackle storage boxes
- Extremely durable with double wall roto-molded construction, high strength nylon handles, nickel plated steel hardware, and polyurethane foam for added protection
- Securely transport and easily access your gear with Ultra-Lock Quick Release Latches

40" Deep | 2890655  
40" Regular | 2890656  
48" Deep | 2890657  
48" Regular | 2890658  
ALL SNOWMOBILES



### CARGO RACK 144" AXYS PRO-RIDE

- Design offers three-level storage with low, medium and high cross bars
- Angled design accommodates tie-down straps to secure cargo

Matte Black | 2881940-458  
ALL AXYS, PRO-RIDE 144



30  
LBS STORAGE

### SWITCHBACK CARGO RACK AXYS

- Strong, durable aluminum construction with easy bolt-on installation
- All mounting hardware included

Aluminum | 2880205  
SWITCHBACK ADVENTURE 2019-2020, SWITCHBACK 2019-2020  
Matte Black | 2880205-458  
ALL AXYS 137 SWITCHBACK PRO-S

### CARGO BAG 144" AXYS PRO-RIDE

- Semi-compressed with nylon side bag installs securely in cargo rack
- Versatile bag can be converted to a single large-cargo compartment

2881968  
AXYS 144, SKS 146, ALL 550 AND 600 VOYAGEUR MODELS  
REQUIRES CARGO RACK 144" (2881940-458), SOLD SEPARATELY



42 LITERS

### BURANDT ADVENTURE UNDERSEAT BAG AXYS

- Dual side-access zippers provide access to cargo when bag is installed

2881056  
AXYS PRO-RMK, AXYS SKS, AXYS RMK ASSAULT



7.7 LITERS

## AXYS - HITCHES



### FLAPPER HITCH

- Multi-purpose flapper hitch for light-to-medium towing for hitch & pin connections
- Constructed from high-strength steel
- Hitch attaches with four simple bolts
- Ready for action within minutes

Black | 2891165  
ALL MATRYX INDY, SWITCHBACK & VOYAGEUR, ALL AXYS 144



### STANDARD

Black | 2890690-067  
Unpainted | 2882859  
ALL MATRYX INDY, SWITCHBACK & VOYAGEUR, ALL AXYS 144



### J-HOOK

2882915  
ALL MATRYX INDY, SWITCHBACK & VOYAGEUR, ALL AXYS 144

EASILY ADAPT YOUR VEHICLE WITH



**LR**  
**FT2 PASSENGER SEAT** AXYS

- Includes backrest, seat and handholds
- Heated grips and plug-in for passenger's heated visor
- Installs/removes easily with Lock & Ride technology
- Requires FT2 Rear Seat Rack (2883646), sold separately

Standard | **2883637**  
ALL AXYS INDY FULL TUNNEL SNOWMOBILES,  
AND AXYS SWITCHBACK ASSAULT

Heated | **2884208**  
ALL AXYS INDY FULL TUNNEL SNOWMOBILES,  
AND AXYS SWITCHBACK ASSAULT

**LR**  
**FT2 REAR SEAT RACK** AXYS

- Attaches via Lock & Ride technology
- Made of powder-coated high-quality steel

**2883646**  
ALL AXYS INDY FULL TUNNEL SNOWMOBILES,  
AND AXYS SWITCHBACK ASSAULT

**FT2 UNDER-RACK BAG** AXYS

- Easy access with weather-resistant zipper
- Compression-molded design provides rigidity
- Attaches directly to rack with water-resistant Velcro®

**2883714**  
ALL AXYS INDY FULL TUNNEL SNOWMOBILES,  
AND AXYS SWITCHBACK ASSAULT



**HAND-WARMER POWER KIT** AXYS

- Required to power the passenger hand-warmers on 2017-2018 AXYS 144 sleds
- 2883851**  
ALL 2017-2018 AXYS 600/800 137 & 144 SWITCHBACK ASSAULT



**LR**  
**X2 BACKREST WITH HANDHOLDS** AXYS

- Enhance passenger comfort and confidence
- Heated handholds
- Provides passenger with comfortable backrest
- Requires X2 Passenger Seat (2880378), sold separately

**2881164**  
SWITCHBACK ADVENTURE, SWITCHBACK PRO-S, SWITCHBACK XCR

**X2 PASSENGER SEAT** AXYS

- Quick and easy installation
- Includes mounting hardware and heavier rear spring
- X2 Backrest with Handholds (2881164), sold separately

**2880378**  
SWITCHBACK ADVENTURE, SWITCHBACK PRO-S, SWITCHBACK XCR



**PASSENGER FOOTRESTS** AXYS

- Add passenger comfort and security with passenger footrests
- Extruded aluminum design attaches directly to running board

SWITCHBACK 137 | **2882817**  
AXYS SWITCHBACK

AXYS 129/137/144 | **2883571**  
AXYS INDY XC 129, SWITCHBACK ASSAULT 144



**REAR TORSION SPRING KITS** MATRYX AXYS

CUSTOMIZE YOUR RIDE BASED ON TOTAL RIDER WEIGHT  
(COMBINED WEIGHT OF RIDER, GEAR AND/OR PASSENGER)

2884973	129/137 Light Duty
2884974 <small>★ TOP SELLER</small>	129/137 Heavy Duty
2884975	129/137 Extra Heavy Duty

ALL MATRYX/AXYS 129 & 137 SNOWMOBILES

2884976	144/146 Light Duty
2884977	144/146 Heavy Duty

ALL MATRYX SWITCHBACK ASSAULT 146,  
AXYS SWITCHBACK ASSAULT 144

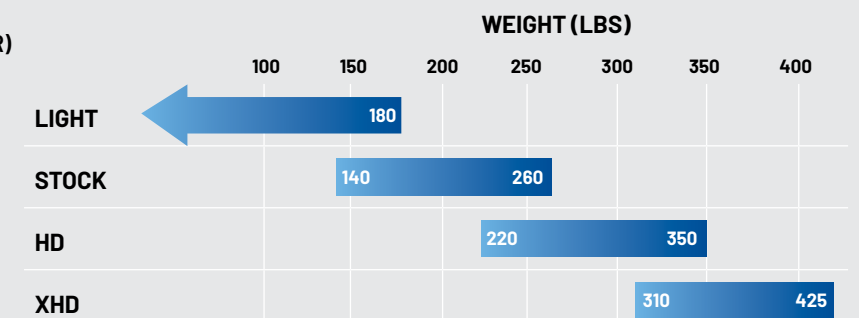

## AXYS - RIDER COMFORT



### HEATED SEAT AXYS

- Features easy-to-use high/low/off switch for complete control
- Complete seat assembly with all mounting hardware and harness included

Black | 2882819  
ALL AXYS 120 - 146 SNOWMOBILES



### RMK BACKCOUNTRY HANDGUARDS MATRIX AXYS

- Provides the ultimate protection for your hands
- Sold in pairs
- Mounts included

Black | 2889868

#### CARBON FIBER COLOR OPTIONS

Indy Red	2890600
Sky Blue	2890601
Neon	2890602

ALL MATRIX AND AXYS RMK

### HANDGUARD MOUNTS AXYS AXYS TITAN

- Strong mounts ensure proper handguard installation
- Easy install: mounts directly onto handlebar

2880939  
ALL AXYS 120 - 146 SNOWMOBILES, ALL TITAN

### RMK HANDGUARD MOUNTS AXYS

- Strong mounts ensure proper handguard installation
- Installs securely on any ProTaper® handlebar

2881241-458  
ALL AXYS RMK

### XL HANDGUARDS AXYS

- Oversized for increased wind protection
- Durable, compression-molded design
- Mounts included

2884258  
ALL AXYS  
DOES NOT FIT AXYS RMK OR TITAN

### POLARIS HANDGUARDS AXYS

- Durable, impact-resistant plastic
- Requires Handguard Mounts, sold separately

Black <small>★ TOP SELLER</small>	2879192
Red	2879193
White	2879194

ALL AXYS  
REQUIRES HANDGUARD MOUNTS, SOLD SEPARATELY

## AXYS - HANDLEBARS

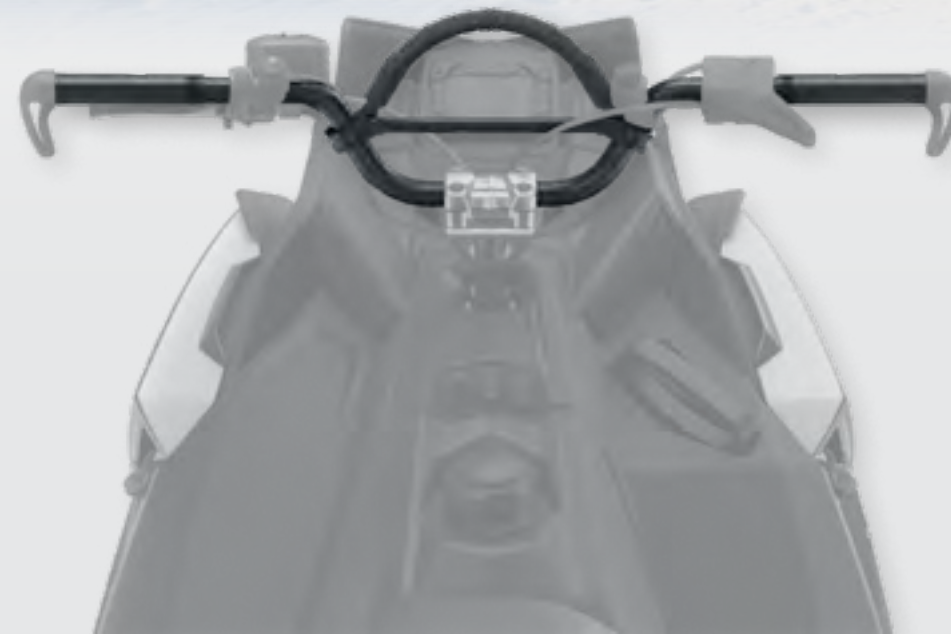

### PROTAPER® HANDLEBAR WITH HEATED GRIPS AXYS

- ProTaper® handlebar allows riders to customize their handlebar height for their riding style
- Handlebar hooks (1823339-070), sold separately
- These handlebars were offered in SnowCheck features and options. Explore the lineup of various sizes to change your fit

5" Rise	Black	2881235
6" Rise	Anodized Gray	2881236
7" Rise	Silver	2881237

ALL AXYS 800 PRO-RMK

5" Rise	Black	2883835
6" Rise	Anodized Gray	2883836
7" Rise	Silver	2883837

ALL 850 - SKS 155, RMK KHAOS, PRO-RMK, PRO RMK 163, PRO RMK 155



### MOUNTAIN HOOP AXYS

2882118  
ALL AXYS 120 - 146 SNOWMOBILES, ALL TITAN



### HANDLEBAR HOOK AXYS

2872482-070  
DOES NOT FIT PROTAPER® BARS



### MIRRORS AXYS

- Wide-angle view with non-fogging glass
- Folding design for use with cover
- Includes mounting hardware
- Sold as a pair

2880292  
ALL AXYS



## AXYS - WINDSHIELDS



DEEP SNOW MID WINDSHIELD



7" TALL

### LOW WINDSHIELD AXYS

	Black/Gray	2880385
	Red/White	2880387
	White	2882062

ALL AXYS



13" TALL

### DEEP SNOW MID WINDSHIELD AXYS

	White	2881054
	Matte Black	2881055
	Gloss Black	2882058

ALL AXYS



18" TALL

### FLATLAND MID WINDSHIELD AXYS

	Clear with Graphic	2880389
	Gloss Black	2880390

ALL AXYS



20" TALL

### TALL WINDSHIELD AXYS

	Smoke	2880394
--	-------	---------

ALL AXYS



24" TALL

### EXTRA TALL WINDSHIELD AXYS

	Clear	2883078
--	-------	---------

ALL AXYS



25" TALL

### FULL COVERAGE WINDSHIELD AXYS

	Clear	2882796
--	-------	---------

ALL AXYS

## AXYS - PROTECTION



PROTECTION: MAXIMUM

MEDIUM

### HIGH COVERAGE SKID PLATE AXYS

- Provides the greatest amount of underbelly protection
- Rugged and lightweight UHMW material
- May hinder deep-snow performance
- Includes all mounting hardware

	Black	2882748-070
--	-------	-------------

ALL AXYS

### ULTIMATE SKID PLATE AXYS

- Extended length delivers extra protection for belly pan and bulkhead
- Includes all mounting hardware

	Black	2880383-070
	Indy Red	2880383-293
	Blue	2880383-619

ALL AXYS



### MONARCH FRONT BUMPER AXYS

	Bright White	2883681-133
	Indy Red	2883681-293
	Matte Black	2883681-458

ALL AXYS



### SENTRY TRAIL REAR BUMPER MATRYX AXYS

	Gloss Black	2884257-067
	Bright White	2884257-133
	Indy Red	2884257-293
	Orange Burst	2884257-647
	Sky Blue	2884257-737
	Polaris Blue	2884257-751
	Stealth Gray	2884257-804

ALL AXYS 129, 137 AND 144/146 SWITCHBACK, ALL MATRYX INDY, SWITCHBACK & VOYAGEUR

## AXYS COVERS

### PREMIUM POLYESTER

- Lightweight, custom fit and extreme protection for the ultimate trailering cover
- Premium UV-resistant and water-repellent capability, great for extended outdoor storage
- Adapts to a full range of windshield heights and secures with integrated straps
- Full Convertible Covers: Cover expands and adapts to fit various accessory configurations

All AXYS Full Tunnel 129, 137, 144 & 146	Full Convertible	2883568
All TITAN	Full Convertible	2882800
PRO-RMK/SKS	¾	2881042
RMK ASSAULT	¾	
RUSH	¾	
SWITCHBACK	¾	2880431
SWITCHBACK ADVENTURE	¾	
RUSH	Full	2882223
SWITCHBACK	Full	2882224
SWITCHBACK with Rack/ADVENTURE	Full	2882225
SWITCHBACK 144	Full	2882133
PRO-RMK 155 / SKS 146/155	Full	
RMK ASSAULT 163/174	Full	2882134



### CANVAS

- Coated, heavy-gauge canvas remains flexible in extreme cold temperatures
- Adjusts to a full range of windshield heights and secures with integrated straps
- Water-repellent, UV-resistant and versatile for trailering or storage

RUSH	Full	2882135
SWITCHBACK 137	Full	2882137
SWITCHBACK ADVENTURE with Rack	Full	2882138
SWITCHBACK ASSAULT 144	Full	2881969
PRO-RMK 155 / SKS 146/155	Full	
RMK 163/174	Full	2881980





**HD FRONT BUMPER** AXYS TITAN

- Add protection to the front of your TITAN with the HD Front Bumper with integrated front-facing winch mount
- Constructed from high-strength steel and finished in black powder coat

Black | 2882794  
ALL AXYS TITAN



**INTEGRATED 1,500LB WINCH**

AXYS TITAN

- Versatile and rugged winch can clear downed trees or retrieve a stuck snowmobile
- Includes wireless winch remote and Side Storage mount
- Mounts to rear of sled with included receiver hitch
- Mounts to front of sled when using HD Front Bumper (Requires 2883850, sold separately)

2882798  
ALL AXYS TITAN

**TITAN FRONT WINCH ATTACHMENT CABLE**

AXYS TITAN

- Required for utilization of the winch in the front of your TITAN snowmobile

2883850  
ALL AXYS TITAN



**VERSA TOURING PASSENGER SEAT** AXYS TITAN

- Attaches/removes in seconds with Lock & Ride technology
- Heated version available
- Includes heated grips and plug-in for passenger's heated helmet visor
- Requires Versa Rear Cargo Rack (2882792), sold separately

Standard | 2882791  
Heated | 2882801  
ALL AXYS TITAN  
STANDARD ON TITAN ADVENTURE



165 LITERS

**SCANDI BOX** AXYS TITAN

- Largest storage option for TITAN with 165 liters of capacity
- Molded to fit seamlessly with the Versa Rear Cargo Rack

2889422  
ALL AXYS TITAN



**CARGO RACK FOR FRONT 1.25" RECEIVER** AXYS TITAN

- Hitch-mounted cargo rack is perfect for carrying all the gear you need
- Constructed from powder-coated steel, this rack will stand up to the toughest loads

2884259  
ALL AXYS TITAN



**PASSENGER FOOTRESTS** AXYS TITAN

- Add passenger comfort and security with passenger footrests
- Extruded aluminum design attaches directly to running board

2882797  
ALL AXYS TITAN

**VERSA REAR CARGO RACK** AXYS TITAN

- Rugged aluminum powder-coated rear rack delivers versatile storage solutions
- Bolts securely to tunnel and features multiple cargo tie-down points

2882792  
ALL AXYS TITAN  
STANDARD ON TITAN ADVENTURE

**VERSA REAR CARGO BOX** AXYS TITAN

- Heavy-duty roto-molded box mounts to rear luggage rack with Lock & Ride technology
- Easy-open hinge lid can accommodate an optional padlock for security
- A total of 60 liters of storage space

2882793  
ALL AXYS TITAN  
STANDARD ON TITAN ADVENTURE



**RUNNING BOARD CLOSE-OUT PLATES**

AXYS TITAN

- Aids in water and slush protection when riding in wet conditions
- Premium polyethylene design delivers lightweight protection

2882810  
ALL AXYS TITAN



**ICE AUGER RACK**

AXYS TITAN

- Premium steel rack securely holds your ice auger for easy transport

2882799  
ALL AXYS TITAN



**TITAN REAR BUMPER HANDLES** AXYS TITAN

- Convenient rear grab points for your TITAN

2882803  
ALL AXYS TITAN



**POLARIS TITAN HEATED SEAT** AXYS TITAN

- Keep warm during the most demanding winter rides
- Features easy-to-use high/low/off switch for complete control
- Complete seat assembly with all mounting hardware and harness included

2882747  
ALL AXYS TITAN



**HUB HOUSE CARRIER**

AXYS TITAN

- Dedicated mount for your hub house
- Secures your hub house in seconds

2884210  
ALL AXYS TITAN



**TAILLIGHT GUARD**

AXYS TITAN

- Protect the top housing of your taillight from stowed gear or accessories
- Rugged aluminum construction secures directly to the rear cargo platform

2882809  
ALL AXYS TITAN



**AXYS - TITAN HITCHES**



**1.25" RECEIVER**

AXYS TITAN

2882795  
ALL AXYS TITAN



**STANDARD HITCH**

AXYS TITAN

2882812  
ALL AXYS TITAN



**BALL HITCH**

AXYS TITAN

- Allows customer to use any size ball with 3/4" shank
- Requires 1.25" Receiver (2882795), sold separately
- Ball not included

2882813  
ALL AXYS TITAN



**HITCH ADAPTER**

AXYS TITAN

- Bolts onto either the J-Hook or Standard Hitch to allow them to be used with 1.25" Receiver installed
- Allows user to change between J-Hook, Standard and Ball Hitch without the use of tools

2882814  
ALL AXYS TITAN



# PRO-RIDE

The Pro-Ride platform delivers consistent performance at an unbeatable value. Enhance your ride with our collection of accessories developed for the Pro-Ride platform, including everything you need for optimized storage, comfort and protection.

## RMK

2024-2025 EVO  
2020-2023 RMK EVO  
2011-2015 PRO RMK  
2011-2015 RMK  
2011-2015 ASSAULT

## SWITCHBACK

2024-2025 SPORT  
2023 550 SPORT  
2011-2016 ASSAULT  
2010-2014 PRO-R  
2012-2014 ADVENTURE

## INDY

2023-2025 550 SPORT  
2019-2025 EVO  
2013-2023 550 LXT/ADVENTURE  
2013-2022 550 121/144  
2013-2021 600

## RUSH

2011-2014 RUSH

## VOYAGEUR

2024-2025 LXT  
2024-2025 ADVENTURE  
2013-2025 550 144/155  
2014-2016 600

### PRO-RIDE - STORAGE

#### RETROFIT YOUR SLED WITH **LR FLEX**

Unlock a world of quick-swap storage, racks, and gear that adapts to your every adventure. From powder days to weekend getaways, transform your snowmobile on the fly and experience the freedom of endless possibilities.

#### LOCK & RIDE FLEX ADAPTER KIT **\* TOP SELLER**

AXYS PRO-RIDE

• Add Lock & Ride Flex storage to AXYS and Pro-Ride full tunnel sleds

2884939

ALL PRO-RIDE & AXYS SLEDs WITH TUNNEL T-SLOTS, NOT COMPATIBLE WITH LOCK & RIDE FLEX M2 SEAT



#### **LR FLEX** SPORT TUNNEL BAG

MATRYX AXYS PRO-RIDE

Low | 2884453

ALL MATRYX, ALL AXYS & PRO-RIDE 121 AND LONGER WITH FULL TUNNEL AND LOCK & RIDE FLEX ADAPTER KIT

Liner Bag - Small | 2889260

Tall | 2884454 **\* TOP SELLER**

ALL MATRYX, ALL AXYS & PRO-RIDE 121 AND LONGER WITH FULL TUNNEL AND LOCK & RIDE FLEX ADAPTER KIT

Liner Bag - Large | 2889261



#### **LR FLEX** ADVENTURE TUNNEL BAG

MATRYX AXYS PRO-RIDE

LOW

Black | 2884455 **\* TOP SELLER**

Liner Bag - Small | 2889262

CARBON FIBER COLOR OPTIONS

■ Sky Blue 2890622  
■ Neon 2890623

ALL MATRYX, ALL AXYS & PRO-RIDE 128 AND LONGER WITH FULL TUNNEL AND LOCK & RIDE FLEX ADAPTER KIT

TALL

Black | 2884456 **\* TOP SELLER**

Liner Bag - Large | 2889263

CARBON FIBER COLOR OPTIONS

■ Orange Burst 2890624  
■ Neon 2890625

ALL MATRYX, ALL AXYS & PRO-RIDE 128 AND LONGER WITH FULL TUNNEL AND LOCK & RIDE FLEX ADAPTER KIT



#### **LR FLEX** WATERPROOF ROLL TOP BAG

MATRYX AXYS PRO-RIDE

• Our highest level of moisture resistance, built to protect your valuables  
• Roll top design allows for quick and easy access

2890008

ALL MATRYX, ALL AXYS & PRO-RIDE 121 AND LONGER WITH FULL TUNNEL AND LOCK & RIDE FLEX ADAPTER KIT



#### EVO TUNNEL STORAGE BAG **PRO-RIDE**

• Provides underseat storage for quick access  
• Compression-molded design provides rigidity  
• Attaches easily with all-weather Velcro® strips

2883671

INDY & RMK EVO

#### TUNNEL BAG **PRO-RIDE**

• Tunnel-top storage provides storage for larger items including clothing and gloves  
• Semi-rigid design retains its shape even when empty  
• Large zippered opening delivers easy storage access

2882788

INDY, INDY SP, INDY ES

## PRO-RIDE - STORAGE



MEDIUM

8.5 LITERS



LARGE

15 LITERS

### LR FLEX BURANDT BAG MATRYX AXYS PRO-RIDE

- Compression molded, turtle shell design for enhanced weather resistance
- Oversized buckles provide easy access to gear with your gloves on
- Integrated mounts for spare shovel jacket enabling riders to carry a secondary shovel
- Installation on AXYS and Pro-Ride sleds requires the Lock & Ride Flex Adapter Kit (2884939), sold separately

#### MEDIUM

Black with zipper closure | **2889258** \* TOP SELLER  
Liner Bag - Medium | **2889349**



#### CARBON FIBER COLOR OPTIONS WITH ROLL TOP LINER

Indy Red	2889895
Sky Blue	2890631
Polaris Blue	2889896
Neon	2890632
Radiant Green	2890633



ALL MATRYX, ALL AXYS & PRO-RIDE 128 AND LONGER WITH FULL TUNNEL AND LOCK & RIDE FLEX ADAPTER KIT

#### LARGE

Black with zipper closure | **2889259** \* TOP SELLER  
Liner Bag - Large | **2889350**



#### CARBON FIBER COLOR OPTIONS WITH ROLL TOP LINER

Indy Red	2889898
Polaris Blue	2889899
Neon	2890634



ALL MATRYX 155 AND LONGER, ALL AXYS & PRO-RIDE 155 AND LONGER WITH FULL TUNNEL AND LOCK & RIDE FLEX ADAPTER KIT



## SPARE SHOVEL JACKET

MATRYX AXYS PRO-RIDE

Jacket | **2889322** \* TOP SELLER  
ALL SNOWMOBILES EQUIPPED WITH A LOCK & RIDE FLEX BURANDT BAG

PIEPS® Shovel T 825 Pro  
+ With Saw Blade | **2883680**  
ALL SNOWMOBILES



## ADVENTURE RACK BAG

MATRYX AXYS PRO-RIDE

- Keep your gear dry with water resistant material
- Includes 1 large roll top compartment, and 1 small rolltop compartment
- Adjustable organizer with zipper and pockets; additional zipper pockets throughout the bag
- Features magnetic Fidlock® buckles for easy and secure use in the cold even with gloves on
- Requires the Adventure Rack (2890018), sold separately

**2890599**

ALL MATRYX 136 AND LONGER, ALL AXYS & PRO-RIDE 136 AND LONGER WITH FULL TUNNEL AND LOCK & RIDE FLEX ADAPTER KIT



47.5 LITERS

## ULTIMATE ADVENTURE SADDLE BAG

MATRYX AXYS PRO-RIDE

- Add even more versatility to the Adventure Rack (2890018) with this saddlebag that can be added to one or both sides of the rack
- Roll top design keeps water out and includes built-in storage pockets to keep smaller items secure
- Features magnetic Fidlock® buckles for easy and secure use in the cold even with gloves on
- Requires the Adventure Rack (2890018), sold separately

**2890612**

ALL MATRYX 136 AND LONGER, ALL AXYS & PRO-RIDE 136 AND LONGER WITH FULL TUNNEL AND LOCK & RIDE FLEX ADAPTER KIT



6 LITERS

## HANDLEBAR BAG PRO-RIDE

- Provides quick, convenient access to essential items
- Semi-rigid design retains its shape even when empty
- Attaches easily with all-weather Velcro® strips

**2882829**

PRO-RIDE INDY, EVO & VOYAGEUR



3.9 LITERS

## PRO-RIDE - RACKS



### VOYAGEUR 155" EXTREME REAR RACK PRO-RIDE

- Strong, durable tubular construction
- Easy bolt-on installation

**2880275**

550 VOYAGEUR, 550 INDY & ADVENTURE 155

### CARGO RACK 144"

AXYS PRO-RIDE

- Design offers three-level storage with low, medium and high cross bars
- Angled design accommodates tie-down straps to secure cargo

Matte Black | **2881940-458**  
ALL AXYS, PRO-RIDE 144

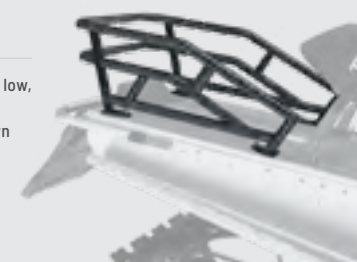

### LR REAR RACK BAG PRO-RIDE

- Compression-molded plastic with zippered closure and zippered expansion panel

**2878731**

INDY EVO, INDY 2017-2020



14.4 LITERS



### ADVENTURE CARGO RACK PRO-RIDE

- Strong, durable aluminum
- Stock rack can be added as rack extension

Brushed Aluminum | **2879846**

ALL PRO-RIDE INDY, SWITCHBACK & VOYAGEUR 144" OR LONGER

### CARGO BAG 144"

AXYS PRO-RIDE

- Semi-compressed with nylon side bag installs securely in cargo rack
- Versatile bag can be converted to a single large-cargo compartment

**2881968**

ALL AXYS, PRO-RIDE 144  
REQUIRES CARGO RACK 144"  
(2881940-458), SOLD SEPARATELY



42 LITERS

## PRO-RIDE - HITCHES & TOWABLES



### ADVENTURE TRAILER

MATRYX AXYS PRO-RIDE

**2890066**

ALL SNOWMOBILES  
LEARN MORE ON P. 36



### OTTER® PRO SLED

MATRYX AXYS PRO-RIDE

Medium (85" L x 32" W x 15" H) | **2890659**  
Magnum (75" L x 38" W x 15" H) | **2890661**  
Large (85" L x 44" W x 17" H) | **2890660**

ALL SNOWMOBILES  
LEARN MORE ON P. 36



### OTTER® PRO-TECH ROD CASE

MATRYX AXYS PRO-RIDE

40 Deep | **2890655**      48 Deep | **2890657**  
40 Regular | **2890656**      48 Regular | **2890658**

ALL SNOWMOBILES  
LEARN MORE ON P. 36



### RECEIVER

**2878344**

550 VOYAGEUR 144/155, 550 INDY LXT,  
550 INDY ADVENTURE 144/155

**2879236**

RMK EVO, 550 INDY EVO, 550 INDY 121

**2880369-458**

ALL AXYS RUSH AND SWITCHBACK



### \* TOP SELLER STANDARD HITCH

**2876677**

COMPATIBLE WITH ALL PRO-RIDE RECEIVERS



### DONUT HITCH

**2874449**

COMPATIBLE WITH ALL PRO-RIDE RECEIVERS



### HEAVY-DUTY J HITCH

**2879838**

COMPATIBLE WITH ALL PRO-RIDE RECEIVERS

## PRO-RIDE - WINDSHIELDS

20"  
TALL

### WIDE WINDSHIELD PRO-RIDE

Clear 2878512

ALL PRO-RIDE

7"  
TALL



### LOW WINDSHIELD PRO-RIDE

Black 2878779

ALL PRO-RIDE

14"  
TALL



### MID WINDSHIELD PRO-RIDE

Smoke 2877841

Matte Black 2879828

ALL PRO-RIDE

24"  
TALL



### EXTRA-WIDE TALL WINDSHIELD PRO-RIDE

Clear 2879156

ALL PRO-RIDE

## PRO-RIDE - RIDER COMFORT & PASSENGER SEATING

### ★ TOP SELLER HOOD MOUNT MIRRORS PRO-RIDE

- Wide-angle view with non-fogging glass
- Folding design for use with cover
- Includes mounting hardware
- Sold as a pair

2877803  
ALL PRO-RIDE



### KNEE PADS PRO-RIDE

• Set of two  
2878195  
ALL PRO-RIDE



### CONVERTIBLE PASSENGER SEAT PRO-RIDE

- Accommodates passenger and cargo up to 150lbs/68kg

2879839  
PRO-RIDE INDY & VOYAGEUR 144" AND LONGER, INDY VOYAGEUR REQUIRES ADVENTURE CARGO RACK (2879846), SOLD SEPARATELY

### HEATED GRIPS PRO-RIDE

- Enhances passenger comfort
- Powered by sled's electrical system

2879840  
PRO-RIDE INDY & VOYAGEUR 144" AND LONGER, INDY VOYAGEUR REQUIRES ADVENTURE CARGO RACK (2879846), SOLD SEPARATELY

### 2-UP TOURING KIT PRO-RIDE

- Enhances driver and passenger comfort
- Includes backrest, seat and handholds

2878157  
PRO-RIDE INDY, VOYAGEUR & SWITCHBACK 144 AND LONGER, REQUIRES TOURING CARGO RACK (2878156), SOLD SEPARATELY



### PASSENGER HAND-WARMER KIT PRO-RIDE

- Provides passenger's hands with heat
- Heater control includes multiple heat settings, including off

2878201  
PRO-RIDE VOYAGEUR, INDY 144

## PRO-RIDE - EVO UPGRADE KITS

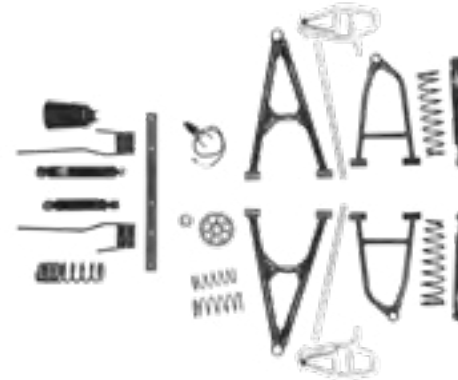

### INDY EVO UPGRADE KIT PRO-RIDE

- Comes with everything you need to evolve your INDY EVO as the rider's skill increases
- Includes tie rods, control arms, spindles, shocks and more
- Convert into a full-speed sled

**NEW** 2891164

INDY EVO 2024-2025

2890307

INDY EVO 2022-2023

2883939

INDY EVO 2020-2021



### RMK EVO UPGRADE KIT PRO-RIDE

- Comes with everything you need to evolve your RMK EVO as the rider's skill increases
- Includes IFS shocks, springs and all the parts needed for full power conversion
- Convert into a full-speed sled

2890308

RMK EVO 2022-2025

2884251

RMK EVO 2020-2021

## PRO-RIDE - PROTECTION



### ULTIMATE FRONT BUMPER PRO-RIDE

Raw 2879727  
Bright White 2879727-133  
Indy Red 2879727-293  
Matte Black 2879727-458

ALL PRO-RIDE



## PRO-RIDE COVERS

### PREMIUM POLYESTER

- Lightweight, custom fit and extreme protection for the ultimate trailering cover
- Premium UV-resistant and water-repellent capability, great for extended outdoor storage
- Adapts to a full range of windshield heights and secures with integrated straps
- Full Convertible Covers: Cover expands and adapts to fit various accessory configurations

RUSH	Full	2882223
SWITCHBACK	Full	2882224
SWITCHBACK with Rack / ADVENTURE	Full	2882225
SWITCHBACK 144	Full	2882133
PRO-RMK 155 / SKS 146/155	Full	2882133
RMK ASSAULT 163/174	Full	2882134



### CANVAS

- Coated, heavy-gauge canvas remains flexible in extreme cold temperatures
- Adjusts to a full range of windshield heights and secures with integrated straps
- Water-repellent, UV-resistant and versatile for trailering or storage

RUSH	Full	2882135
SWITCHBACK 137	Full	2882137
SWITCHBACK ADVENTURE with Rack	Full	2882138
SWITCHBACK ASSAULT 144	Full	2881969
PRO-RMK 155 / SKS 146/155	Full	2881969
RMK 163/174	Full	2881980
INDY 121 / INDY EVO	Full	2878725
550 INDY 144	Full	2879845
INDY VOYAGEUR 144	Full	2879845
INDY LXT	Full	2880515
INDY VOYAGEUR 144/155 with 2-Up Seat	Full	2880515
INDY VOYAGEUR 155	Full	2880516
All Pro-Ride 144/155	Full	2879844

## RIDE READINESS



### POLARIS RIDECOMMAND

SEE P. 10 FOR MORE DETAILS

#### 7S DISPLAY MATRYX

2884971 ★ TOP SELLER  
ALL MATRYX, REQUIRES 7S DISPLAY INSTALL KIT (2884972), SOLD SEPARATELY

#### 7S DISPLAY INSTALL KIT MATRYX

• Required for 7S Display installation  
2884972 ★ TOP SELLER  
ALL MATRYX

## TRAIL TECH

### VOYAGER PRO GPS MATRYX AXYS PRO-RIDE

ADD ANY VEHICLE TO YOUR POLARIS RIDE GROUP, RUGGED OFF-ROAD GPS, RIDE COMMAND COMPATIBLE WITH GROUP RIDE CONNECTIVITY, CUSTOM MAPS AND VEHICLE INTEGRATION

SEE P. 11 OR TRAILTECH.NET FOR MORE DETAILS



### KEY-OPERATED ELECTRIC START KIT MATRYX AXYS PRO-RIDE

- Easier to use and more convenient than pull starts
- Ideal for extreme cold conditions
- Battery required and not included

2881243  
ALL AXYS PRO-RMK, SKS,  
AXYS RMK ASSAULT  
2880396  
ALL AXYS RUSH, SWITCHBACK  
2883931  
ALL AXYS 850 PRO-RMK  
2883849  
ALL AXYS 850 RUSH, INDY XC, SBA  
2879330  
ALL PRO-RIDE

2879833  
VOYAGEUR 550, INDY 550  
2884955  
ALL MATRYX 128, 129, 137, 138,  
AND SBA 146  
2889361  
ALL MATRYX RMK (NON-BOOST)  
2889362  
MATRYX RMK BOOST  
2884776  
ALL 800 AXYS, SWITCHBACK,  
& RUSH

2884777  
ALL 800 2020 AXYS RMK  
2890511  
ALL MATRYX 9R  
2890130  
MATRYX VR1 & SBA BOOST



### TETHER SWITCH

- Shuts off vehicle if you're separated from it
- Easy to install, mounts directly on pod, connects to prewired harness

2874379 ★ TOP SELLER  
ALL SNOWMOBILES  
2883823  
ALL 850 SNOWMOBILES



### MAGNETIC TETHER

- Shuts off vehicle if you're separated from it
- Magnetic engagement enhances connection and retention
- Easy to install: mounts directly to console via a pre-wired harness

2889143  
ALL 600/800 SNOWMOBILES  
2889142 ★ TOP SELLER  
ALL 650/850 SNOWMOBILES



RCA ADAPTER

### 12 VOLT/RCA PLUGS

- 12v accessory plugs into 12v outlet, great for GPS or phone, dash mount
- RCA adapter allows you to plug in a heated face shield or vest
- RCA power plug includes all hardware required to add an RCA outlet
- Includes splitter to use with Auxiliary Lighting, see P. 18 for lighting

RCA Power Plug | 2883824 ★ TOP SELLER 12v | 2878475  
ALL 650, 850, S4 ALL AXYS, ALL PRO-RIDE  
RCA Adapter | 2878227 12v | 2890259 ★ TOP SELLER  
ALL AXYS, ALL PRO-RIDE ALL MATRYX  
RCA Power Plug | 2878780 ★ TOP SELLER  
ALL AXYS, PRO-RIDE, AND TITAN

## CRUZTOOLS®



### CRUZTOOLS® KIT

- Tool kit consists of all the tools you'll need for most trailside repairs
- Multiple types of tools ranging from wrenches, ratchets, pliers and zip ties
- Comes with tool roll to hold all the tools in one easy to carry place

2890687  
ALL SNOWMOBILES



### REVERSIBLE ICE SCRATCHERS MATRYX AXYS

- Maintains optimum track and engine temperature in a wider variety of snow conditions delivering an enhanced riding experience
- Single coil design for increased durability on the trail
- Fully reversible scratchers for added durability and convenience

2890644  
RMK MODELS  
STANDARD ON 2024 RMK MODELS



### RMK BOGIE WHEEL KIT AXYS PRO-RIDE

- Wheels install on stock skid
- Reduces hi-fax wear on hard-pack snow and ice
- A total of three pairs can be installed onto a stock skid

2882048  
ALL AXYS RMK  
2878251  
ALL PRO-RIDE RMK



### VESPEL® HYFAX MATRYX AXYS PRO-RIDE

- Long lasting VespeL® Hyfax allows for more miles compared to standard extruded plastic option hyfax
- Made from stronger compound than the plastic option

2889115  
ALL SNOWMOBILES 120-146

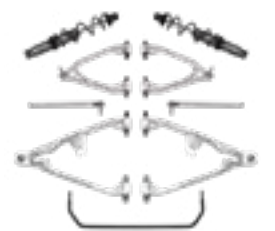

### RMK REACT FRONT SUSPENSION KIT AXYS

- Comes with everything you need to convert your AXYS PRO-RMK to a 36" wide front end
- Includes shocks, upper and lower control arms, tie rods, sway bar and all hardware

2883686-309  
ALL AXYS RMK  
STANDARD ON 2019 & NEWER PRO RMK & RMK KHAOS MODELS

FOR ADDITIONAL SHOCKS VISIT  
[POLARIS.COM/SUSPENSION](https://www.polaris.com/suspension)

## COLOR CUSTOMIZATION



Give your sled a custom-finished look with factory-color-matched skis, ski toes and spindles. The combinations are endless.

### MOUNTAIN



#### \* TOP SELLER GRIPPER SKI

MATRYX AXYS PRO-RIDE

- Deep 1.5" keel provides positive steering in deep, loose mountain snow
- Wide 6.75" ski delivers increased flotation
- Top traction surface for boot stepping on ski
- Includes black ski toe and hardware
- Requires carbide skags, sold separately
- Black comes standard on all RMK models
- Sold individually

Black	2877679-070
Indy Red	2877679-293
White	2877679-570

ALL SNOWMOBILES



#### SKI TOE

Black	2889421-070
White	2889421-133
Indy Red	2889421-293
Orange Burst	2889421-647
Sky Blue	2889421-737
Plum Crazy	2889421-784
Polaris Blue (Non-Metallic)	2889421-795
Stealth Gray	2889421-804

ALL POLARIS SKIS

### UTILITY



#### PRO-FLOAT SKI

MATRYX AXYS PRO-RIDE

- Adapted, 9.5" wide Pro-Steer ski design provides 45% more flotation for off-trail deep-snow performance
- Includes black ski toe
- Sold individually

Black	2880482
-------	---------

ALL SNOWMOBILES



#### SPINDLES

- Strong, lightweight aluminum construction with same tolerances as stock spindles
  - Exact replacement for stock spindles
- RUSH/SWITCHBACK FITMENT: ALL AXYS 120 - 144 SNOWMOBILES  
FORGED RMK FITMENT: ALL AXYS RMK

### TRAIL



#### PRO-STEER SKI

MATRYX AXYS PRO-RIDE

- Engineered keel design and shortened skag perfect for the trail
- Supportive ribs for torsional stiffness
- No-slip traction atop ski
- Alternate ski stop may be required
- Includes black ski toe and hardware
- Black comes standard on all Indy and Switchback models
- Sold individually
- Carbide skags required, sold separately

Black	2885164-070
Bright White	2885164-133
Indy Red	2885164-293

ALL SNOWMOBILES



#### RUSH/SWITCHBACK FORGED RMK

Gloss Black	--	2884205-067
Indy Red	--	2884205-293
Matte Black	2881409-458	--
Orange Burst	--	2884205-647



At Cobra Cords we are focused on creating high performance pull start cords. Our products utilize fiber, braiding and coating technologies to create a pull cord that is engineered to last. Cobra Cords are 100% lifetime guaranteed.

### SNOWMOBILE COBRA CORD

Black	2889918	* TOP SELLER
Red	2889919	
Blue	2889920	
Purple	2889921	
Pink	2889922	

ALL SNOWMOBILES



MAKE IT YOURS WITH A CUSTOM WRAP BY ARCTICFX.®

BUILD YOURS NOW  
[POLARIS.COM/AFXWRAPS](http://POLARIS.COM/AFXWRAPS)



★ TOP SELLER

2882998	TraxGrabber
2882970	72" TraxMat
2882967	Grips (set of 6)
2882979	LowPro Glide - Standard 9" Double Set - 16pc. (40' Kit)
2882983	LowPro GripGlide - Standard 9" Double Set - 16pc. (40' Kit)
2882984	Flex Glides Low Profile (set of 8)
2882985	Flex Glides High Profile (set of 8)
2884383	EdgeGuard - 12pc. Kit
2884382	Edge Glide 2.0 - 4pc. Kit (96")
2882989	Poly Shield Series III
2882990	V-Front Ramp Shield Disco
2883004	Retrax - Self-Retracting Strap Set

POLARIS PART NUMBERS UTILIZED IN CHART ABOVE. ONLY TOP SELLERS PROVIDED. FULL PRODUCT LINE DETAIL IS AVAILABLE IN THE CONFIGURATOR.



LowPro Glides

TraxMat

LowPro GripGlides

Edge Glides

Trax Grabber

## CUSTOMIZE YOUR TRAILER WITH THE POLARIS ONLINE CONFIGURATOR

Fully customize your trailer using the Polaris online configurator. Select from the full range of Caliber® trailer products and when finished print a detailed parts list based on your selections.

VISIT [POLARIS.COM/TRAILERING](http://POLARIS.COM/TRAILERING)



### SLED WHEELS

- New improved polymer
  - Provides amazing mobility for snowmobiles
  - Universal modular design works with most snowmobile skis
  - Innovative design provides fast engagement and disengagement
- Carbon Black | 2883853

### RAMP PRO 2.0

#### 1,500 POUND RATING

- Innovative ramp design for snowmobiles, ATVs, UTVs and golf carts
- Improved 2.0 design features 12" wide glides accommodating narrow RMK ski stances

2884576 **★ IMPROVED DESIGN**  
ALL SNOWMOBILES



Ramp Grips | 2882968

#### TRACTION AND GLIDE



#### INTEGRATED FINGERS



#### INTEGRATED FEET



### TRAX WHEELS 2.0

#### 500 POUND RATING

- Tapered sides allow track to easily drop in place
- Specifically designed to accommodate all track pitches: 2.52", 2.86" and 3.0"
- Over-sized 5" urethane casters make moving over rough surfaces a breeze

2884384



Integrated Self-Retracting Strap Included



### FRONT CLAMP

- Adjustable to fit all snowmobiles
- Rubber silicone pads protect and secure skis
- Integrates to all trailers
- Includes deck hook

2882961  
ALL SNOWMOBILES



### REAR CLAMP

- Composite construction with silicone rubber padding
- Tension adjustment knob to fit all snowmobiles
- Secures via rear suspension skid
- 12" Supertrac Kit included

2882962



### SUPERCLAMP® DECK HOOK

2882963



### SUPERCLAMP® TRAC HOOK

2882965

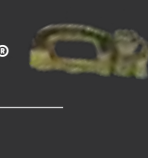

### SUPERCLAMP® TRAC

• 12" length  
2882964





## TRACTION & CONTROL

# RIP WITH AN IRON GRIP

Whether you're replacing your carbides or looking to add more traction and control for enhanced performance, premium Woody's® stud kits and carbide runners are exclusively engineered for your Polaris snowmobile.



## CONTROL FOR HOW YOU RIDE

### TUNNEL PROTECTION

Required protection for when you stud, these "wear strips" protect your tunnel and vital cooling components from damage.

### CARBIDES

Replacing or upgrading, add the right amount of ski control to match your track length, studding pattern and riding style.

### STUDS

Choose the right length stud for your track lug and then select a pattern to best suit your riding style for a touch of added control to monster holeshots.

### CARBIDE WEAR STRIPS

Carbides need to be sharpened or replaced periodically due to normal wear and use. Rocks, cement, pavement and road crossings all contribute to carbide wear.

**3"-4" CARBIDE**

Perfect for sleds with a 121" track with 96 studs or less or sleds with 1" lugs taking corners at moderate speeds

**6" CARBIDE**

Ideal for sleds in the 136" track range with up to 1 1/4" lugs or shorter track sleds with more than 96 studs

**8" CARBIDE**

Best for ultimate-performance sleds with a 144" track or longer with paddles and/or the maximum amount of studs



### SINGLE RUNNER

Provides known reliability, handling and control.

SKI	NOTE	3"	4"	6"	6"	8"	8"
Pro-Steer/Pro-Float	Sold in Pack of 2	--	2879025 <b>★ TOP SELLER</b>	--	2879026 <b>★ TOP SELLER</b>	--	2879027
Gripper	Sold in Pack of 2	2875723 <b>★ TOP SELLER</b>	--	2877880	--	2877881	--

### DOUBLE RUNNER

Provides an increase in steering control in icy conditions and minimizes darting when riding on packed trails. Perfect to pair with a studded track.

SKI	NOTE	SLIM JIM		DOOLY	
		4"	6"	4"	6"
Pro-Steer/Pro-Float	Sold Individually	2891044	2891045	2891042	2891043

## woody's STUD KITS

Includes everything to update your sled's traction—Gold Digger® studs, nuts, backer plates, template and track drill bit.



ENGINE	TRACK	TRACK LENGTH	LUG HEIGHT	PITCH	STUD QUANTITY	STUD KIT
600/650	1.5" Storm	137	1.5	2.86	GDP6-1575: 96	2890458
800/850	1.5" Storm	137	1.5	2.86	GDP6-1575: 144	2890459
650	1.6" Cobra	128	1.6	2.52	GDP6-1575: 102	2890460
850	1.6" Cobra	128	1.6	2.52	GDP6-1575: 153	2890461
650/S4	1.5" Ice Storm/1.6" Cobra	146	1.5/1.6	2.86	GDP6-1575: 102	2890462
850	1.5" Ice Storm/1.6" Cobra	146	1.5/1.6	2.86	GDP6-1575: 153	2890463
650	1.6" Cobra	136	1.6	2.52	GDP6-1575: 108	2890464
850	1.6" Cobra	136	1.6	2.52	GDP6-1575: 162	2890465
650	1.5" Storm	129	1.5	2.86	GDP6-1575: 90	2890466
850	1.5" Storm	129	1.5	2.86	GDP6-1575: 135	2890467
600	1.6" Cobra	144	1.6	2.52	GDP6-1575: 114	2890468
550	1.6" Cobra	155	1.6	2.86	GDP6-1575: 108	2890469
800/S4	1.5" Cobra	155	1.5	2.86	GDP6-1575: 108	2890470
600/650	1.25" Ice Ripper XT 1.352" Cobra	128	1.25/1.352	2.52	GDP6-1325: 102	2890471
800/850	1.25" Ice Ripper XT 1.352" Cobra	128	1.25/1.352	2.52	GDP6-1325: 153	2890472
600/650/S4	1.25" Ice Ripper 1.352" Cobra 1.25" Ice Ripper XT 1.25" Ripsaw II	129	1.25/1.352	2.86	GDP6-1325: 90	2890473
800/850	1.25" Ice Ripper 1.352" Cobra 1.352" Cobra R 1.25" Ice Ripper XT 1.25" Ripsaw II	129	1.25/1.352	2.86	GDP6-1325: 135	2890474
600/650	1.25" Ice Ripper 1.352" Cobra	136	1.25/1.352	2.52	GDP6-1325: 108	2890475
800/850	1.25" Ice Ripper 1.352" Cobra 1.25" Ripsaw II	136	1.25/1.352	2.52	GDP6-1325: 162	2890476
600/650/S4	1.25" Ice Ripper 1.352" Cobra 1.25" Ice Ripper XT 1.25" Ripsaw II	137	1.25/1.352	2.86	GDP6-1325: 96	2890477
800/850/BOOST	1.25" Ice Ripper 1.352" Cobra 1.352" Cobra R 1.25" Ice Ripper XT 1.25" Ripsaw II	137	1.25/1.352	2.86	GDP6-1325: 144	2890478
550/600	1.352" Cobra	144	1.352	2.52	GDP6-1325: 114	2890479
650/S4	1.352" Cobra	146	1.352	2.86	GDP6-1325: 102	2890480
850/BOOST	1.352" Cobra	146	1.352	2.86	GDP6-1325: 153	2890481
S4	1" Ripsaw II	129	1	2.86	GDP6-1075: 90	2890482
BOOST	1" Ripsaw II R	129	1	2.86	GDP6-1075: 135	2890483
S4	1" Ripsaw II	137	1	2.86	GDP6-1075: 96	2890484
BOOST	1" Ripsaw II R	137	1	2.86	GDP6-1075: 144	2890485
550	1" Energy	144	1	2.52	GDP6-1075: 114	2890486
800	1.5" Cobra	155	1.5	2.86	GDP6-1575: 108	2890487
800	1.375" Ripsaw	155	1.375	2.86	GDP6-1450: 108	2890488
800	1.5" Cobra	155	1.5	2.86	GMP-1575: 108	2890489

ACCESSORIES

LOCK & RIDE FLEX

POLARIS PARTNERS

CONNECTED TECHNOLOGY

MATRYX

AXYS

PRO-RIDE

RIDE READINESS

COLOR CUSTOMIZATION

TRANSPORT

TRACTION & CONTROL

TRACKS

# FOUR KEYS TO TRACK SELECTION

## LENGTH

The inside circumference of the track is calculated as the drive pitch multiplied by the number of track segments. It must be correct to the nearest inch for proper fit without additional modifications to the skid frame.

## DRIVE PITCH

The drive cog center distance around the circumference of the cogs on the drive axle. It must match the existing track or the drive cogs must be changed.

## WIDTH

The measurement across the track governed by the width of the tunnel.

## LUG HEIGHT

The distance lugs extend above the track surface.

- Trail: 1" - <1.5"
- On/Off Trail: 1.5" - <2"
- Deep Snow: 2" and greater



SEE ALL TRACKS OPTIONS AT [POLARIS.COM/TRACKS](http://POLARIS.COM/TRACKS)

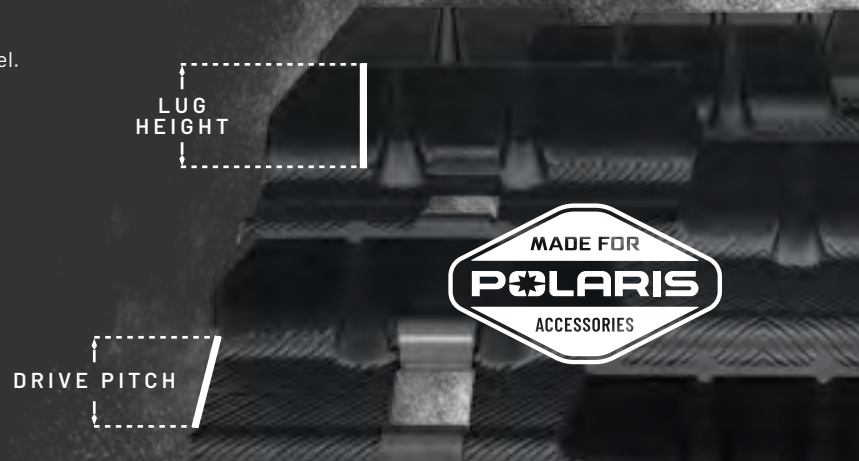

### ICE RIPPER

ON TRAIL OFF TRAIL

- Factory pre-studded for improved traction and control
- 1.25" lug height for improved traction and stability
- RipSaw-based attack angled lugs for excellent forward and lateral bite

LENGTH	PITCH	LUG HEIGHT	
137"	2.86"	1.25"	5416995



### HACKSAW

ON TRAIL OFF TRAIL

- 1" lug height for low rolling resistance that improves fuel economy
- Crescent lug features recessed tips and cutting edges for forward and lateral bite on hard-pack
- Hard-wearing rigid lugs for mile after mile of dependable use
- Narrow lug base to reduce rolling resistance and maximize top speed

LENGTH	PITCH	LUG HEIGHT	
121"	2.52"	1"	5413198
136"	2.52"	1"	5413318



### ICE ATAK XT

ON TRAIL OFF TRAIL

- Factory-pre-studded for improved traction and control
- Designed to provide even better ice performance than the ICE Ripper XT
- 1.22" lug height provides better handling and stability
- Optimized rubber compound for superior traction on groomed trail

LENGTH	PITCH	LUG HEIGHT	
120"	2.86"	1.22"	2839190
121"	2.52"	1.22"	2839200
128"	2.52"	1.22"	2839201
129"	2.86"	1.22"	2839236
136"	2.86"	1.22"	2839202
137"	2.86"	1.22"	2839191
144"	2.52"	1.22"	2839203



### ICE STORM 150

ON TRAIL OFF TRAIL

- Two-height lug design offers deep-snow flotation with handlebar-gripping acceleration
- Factory-pre-studded for improved traction and control on icy conditions
- 1.25" outer lugs and 1.5" cup-shaped center lugs provide power and traction on packed trails and turns

LENGTH	PITCH	LUG HEIGHT	
120"	2.86"	1.25"	2839388
129"	2.86"	1.25"	2839389
137"	2.86"	1.25"	2839390
146"	2.86"	1.25"	2839391



### HURRICANE

ON TRAIL OFF TRAIL

- Designed based on mountain tracks, it provides off-trail performance in deep snow while maintaining on-trail agility
- 1.75" cupped profile design provides unparalleled grip in the backcountry
- 1.75" tall lug profile design reduces vibration, applying more power to the ground

LENGTH	PITCH	LUG HEIGHT	
120"	2.86"	1.75"	2839400
129"	2.86"	1.75"	2839401
137"	2.86"	1.75"	2839402
146"	2.86"	1.75"	2839403



### COBRA

ON TRAIL OFF TRAIL

- Cupped lugs for superior acceleration and braking in loose, soft-snow conditions
- Flexible lug design for superior off-trail performance

LENGTH	PITCH	LUG HEIGHT	
120"	2.86"	1.352"	2839284
121"	2.52"	1.352"	2839052
129"	2.86"	1.352"	2839235
136"	2.52"	1.352"	2839061
137"	2.86"	1.352"	2839307
137"	2.86"	1.352"	5413661
144"	2.52"	1.352"	2839107
144"	2.86"	2.52"	5414013
144"	2.86"	1.6"	5416162
155"	2.86"	1.5"	5415826
155"	2.86"	1.8"	5416020
136"	2.52"	1.352"	5413655
128"	2.52"	1.352"	5416296
129"	2.86"	1.352"	5416604



### STORM 150

ON TRAIL OFF TRAIL

- 1.25" outer lugs provide power through the tightest turns with ease, maintaining momentum and rider control
- 1.5" cup-shaped center lugs provide deep snow flotation and gut-wrenching acceleration on packed trails
- Optimized support columns provide the right balance of lug rigidity and flex for performance across the entire power band

LENGTH	PITCH	LUG HEIGHT	
120"	2.86"	1.25"/1.5"	2839368
129"	2.86"	1.25"/1.5"	2839369
137"	2.86"	1.25"/1.5"	2839370
146"	2.86"	1.25"/1.5"	2839371
137"	2.86"	1.25"/1.5"	5416618
129"	2.86"	1.25"/1.5"	5416605



### RIPSAW

ON TRAIL OFF TRAIL

- Rigid lugs provide superior handling, acceleration and braking on groomed trails
- Narrow lug base for reduced rolling resistance and maximum top speed
- Angled profiles for aggressive forward and lateral bite

LENGTH	PITCH	LUG HEIGHT	
136"	2.52"	1.5"	2877648
120"	2.86"	1.25"	2839149
121"	2.52"	1.25"	2839968
128"	2.52"	1.25"	2839215
136"	2.52"	1.25"	2839969
155"	2.86"	1.375"	5416227



### RIPSAW 2

ON TRAIL OFF TRAIL

- Tapered outside lug edges for less side bite when cornering
- Sharp angled lugs for excellent bite on hard-pack snow
- Cupped center and full outer lugs for traction on loose, less-compacted snow

LENGTH	PITCH	LUG HEIGHT	
120"	2.86"	1.25"	2839209
120"	2.86"	1.25"	5414653
121"	2.52"	1.25"	2839214
129"	2.86"	1.5"	2839305
136"	2.52"	1.25"	2839216
137"	2.86"	1.5"	2839306
137"	2.86"	1.25"	5414654
129"	2.86"	1.25"	5416585

**MOUNTAIN**

**SERIES 9**

ON TRAIL OFF TRAIL

- All new 3.5" pitch track with 3.25" tall lugs for deep snow riding
- Spools up quickly and puts the power down to the snow
- Features an aggressive Polaris-exclusive lug design for instant traction and forward drive in deep snow
- Fits only with 2024 Dual Extrovert Driveshaft

LENGTH	PITCH	LUG HEIGHT	
155"	3.5"	3.25"	5418540
165"	3.5"	3.25"	5418541

**SERIES 8**

ON TRAIL OFF TRAIL

- Lightweight 3.5" pitch track with 2.75" lugs optimized flex and improved stiffness
- Reduces mass and lowers inertia resulting in instantaneous lift, superior traction and optimum flotation for all types of mountain riding
- Fits the New Dual Extrovert Driveshaft\*

LENGTH	PITCH	LUG HEIGHT	
155"	3.5"	2.75"	5415140
155"	3.5"	2.75"	5418047*
165"	3.5"	2.75"	5416367*
165"	3.5"	2.75"	5418048

**SERIES 7**

ON TRAIL OFF TRAIL

- Polaris exclusive
- Ideal track to provide lift in the deepest, softest snow conditions
- Features a new lightweight single-ply design optimized for weight and powder snow performance

LENGTH	PITCH	LUG HEIGHT	
155"	3"	3"	5415393
163"	3"	3"	5415394
174"	3"	3"	5415786

**SERIES 6**

ON TRAIL OFF TRAIL

- Outstanding traction and control in deep snow
- Lugs provide tremendous flotation and great performance
- 2.6" lugs provide outstanding traction in all deep-snow conditions
- Design provides outstanding flotation and control

LENGTH	PITCH	LUG HEIGHT	
155"	2.86"	2.6"	5415391
163"	2.86"	2.6"	5415392
155"	2.86"	2.6"	5416838

**MOUNTAIN**

**SERIES 5.2**

ON TRAIL OFF TRAIL

- Modeled after the modified Series 5.1 track used by Polaris hill climb racers
- Provides great traction both on- and off-trail
- Maintains excellent durability
- Optimized lug pattern for more forward lug contact

LENGTH	PITCH	LUG HEIGHT	
146"	2.86"	2.25"	5416498

**SERIES 5.1**

ON TRAIL OFF TRAIL

- Industry-leading deep-powder track; for 8T drive sprockets, 2.86" pitch
- Optimized lug pattern producing 19% more forward lug contact compared to our Series 5.0 track
- Soft and flexible tips for superior performance in deep snow

LENGTH	PITCH	LUG HEIGHT	
155"	2.86"	2.4"	5413622
163"	2.86"	2.4"	5413621

**SERIES 4**

ON TRAIL OFF TRAIL

- The standard in 2" deep-snow tracks; for 9T drive sprockets, 2.52" pitch
- Equal parts versatility and durability
- Stiff lug base for long wear and hard-pack performance
- Soft and flexible tips for superior performance in deep snow

LENGTH	PITCH	LUG HEIGHT	
144"	2.52"	2"	5413073
144"	2.52"	2"	5415692

**PEAK 2.25**

ON TRAIL OFF TRAIL

- Angular lugs bite and funnel snow under the snowmobile for outstanding flotation
- Features soft lugs for powder snow and hard lugs for heavy/wet snow
- Outer lug bars deliver better lateral control for improved handling

LENGTH	PITCH	LUG HEIGHT	
155"	2.86"	2.25"	5415002

**MOUNTAIN**

**EPIC**

ON TRAIL OFF TRAIL

- Reduced vibration and improved handling in deep snow
- Unique deep cup shaped lug design
- Stiffer columns design improves packed snow grip, riding agility and braking

LENGTH	PITCH	LUG HEIGHT	
162"	3"	2.8"	2839407
156"	3"	2.8"	2839408

**SHOCKWAVE**

ON TRAIL OFF TRAIL

- Designed for hard-working, utility applications
- Able to handle heavy workloads in deep-snow, off-trail environments
- Tackles on-trail and hard-packed applications

LENGTH	PITCH	LUG HEIGHT	
156"	2.52"	1"	5414453
121"	2.52"	0.91"	5412281

**COMPETITION TRACK**

ON TRAIL OFF TRAIL

- Customized for competition
- Developed for and tested by top Polaris racers

LENGTH	PITCH	LUG HEIGHT	
155"	2.86"	2.1"	2877304

**YOUTH 120**

ON TRAIL OFF TRAIL

- Replacement track for the Polaris 120 INDY

LENGTH	PITCH	LUG HEIGHT	
68"	2.55"	.71"	5411751

**MISCELLANEOUS**

**CROSSOVER**

**BACKCOUNTRY**

ON TRAIL OFF TRAIL

- Arched lug design with staggered, snocross-inspired pattern for excellent soft-snow traction

LENGTH	PITCH	LUG HEIGHT	
120"	2.86"	1.75"	5414894
121"	2.52"	1.75"	2839140
121"	2.52"	1.75"	5415097
136"	2.52"	1.75"	2839142
136"	2.52"	1.75"	5414378
137"	2.86"	1.75"	5414895
144"	2.52"	1.75"	5415096
144"	2.52"	1.75"	2839143
128"	2.52"	1.75"	5417031

**COBRA 1.6**

ON TRAIL OFF TRAIL

- Cupped lugs for superior acceleration and braking in loose, soft-snow conditions
- Flexible lug design for superior off-trail performance
- Select lugs are more rigid for traction on hard-packed snow

LENGTH	PITCH	LUG HEIGHT	
155"	2.86"	1.6"	5414902

**ICE COBRA 1.6**

ON TRAIL OFF TRAIL

- Cupped lugs for superior acceleration and braking in loose, soft-snow conditions
- Flexible lug design for superior off-trail performance
- Factory-pre-studded with 1.6" lugs for excellent all-round performance, especially on ungrooved trails

LENGTH	PITCH	LUG HEIGHT	
137"	2.86"	1.6"	2839246
155"	2.86"	1.6"	2839273

**CHALLENGER**

ON TRAIL OFF TRAIL

LENGTH	PITCH	LUG HEIGHT	
144"	2.52"	2"	2839875
146"	2.86"	2.5"	2839145
151"	2.52"	2"	2839876
154"	2.86"	2.5"	2839104
162"	3"	2.5"	2839319
163"	2.86"	2.5"	2839105

**CROSSOVER**

**SNOW CROSS**

ON TRAIL OFF TRAIL

- Customized for snocross competition
- Developed for and tested by top Polaris racers

LENGTH	PITCH	LUG HEIGHT	
129"	2.52"	1.75"	5450277

**BACKCOUNTRY X2**

ON TRAIL OFF TRAIL

- Arched lug design with staggered snocross-inspired pattern for excellent soft snow traction
- Rigid lug support columns and optimized rubber compound to deliver great on/off-trail performance
- 2.86" drive pitch

LENGTH	PITCH	LUG HEIGHT	
146"	2.86"	2"	2839417

**ICE COBRA WT**

ON TRAIL OFF TRAIL

- Extra-high 1.5" lugs for the best possible traction
- Cupped lug design ideal in soft, loose snow and for off-trail backcountry exploration
- Lightweight for greater efficiency and improved fuel economy

LENGTH	PITCH	LUG HEIGHT	
155"	2.86"	1.5"	2839414

FITS TITAN MODELS



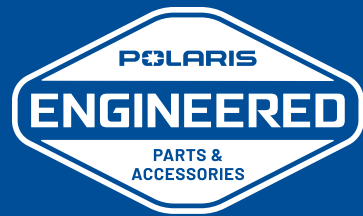

# GARAGE

## FACTORY APPROVED.

Every Polaris snowmobile has been engineered and manufactured to deliver performance. Polaris Engineered parts & oil have gone through the same rigorous testing. To maintain peak performance, only use Polaris Engineered parts and oil.

### GARAGE CONTENTS

- 72 Maintenance
- 74 Oil
- 78 Lubricants & Garage Accessories
- 80 Belts, HD Parts & Battery Chargers
- 82 Polaris Power
- 84 Service Parts



**BATTERIES**

Cold weather, harsh conditions and time can degrade a battery. A genuine Polaris replacement ensures an exacting fit and starting performance.

**SPARK PLUGS**

New spark plugs, engineered specifically for your Polaris snowmobile, ensure quick starts, fuel efficiency and peak performance.

**DRIVE BELTS**

Only genuine Polaris Engineered Drive Belts provide a fit and optimum compound for maximum performance and reliability.

**BREAK-IN PERIOD**

The break-in period for a new belt is 50 miles (80.5 kilometers). During this time, vary at moderate speeds while avoiding wide-open throttle.



**TRACKS**

Enhance traction and control or replace a worn track with the latest trend in track pitch, length, lug height and patterns.

**STUDS**

Enhance your snowmobile's traction, control and performance with premium studs designed for your sled, track and riding style.

**RAIL SLIDERS**

Replace worn hyfax with genuine Polaris rail sliders for a perfect fit and engineered compound for optimum performance.

**CARBIDES**

Replace worn carbides or enhance your sled's handling with engineered exact fit wear bars with your choice of high-wear carbide length.

**MAINTENANCE PARTS**



**BATTERIES**

2-Stroke | 4013045  
4-Stroke | 4018013



**OIL FILTER**

2522606



**SPARK PLUGS**

Engineered for your Polaris sled  
2-Stroke | NGK® | 3022082  
2-Stroke | Champion | 3070190  
4-Stroke | NGK® | 3022662

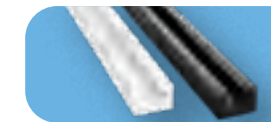

**RAIL SLIDERS**

5521632 5521633-309  
5521633-070 5522144-070

**FOR THE LIFE OF YOUR RIDE**

We do more than build the world's greatest snowmobiles. We also work tirelessly to make sure the maintenance products you need are engineered to the same demanding standards. When it comes to drive belts, lubricants, batteries and more, we invest the time to make sure they're right, so you can spend more time riding.



SCAN THE QR CODE TO SEE OUR LATEST MAINTENANCE TIPS

**MAINTENANCE SCHEDULE**

Check your owner's manual for additional recommended service items and vehicle-specific timing.

	PRE-SEASON	500mi (800km) IN-SEASON	2,000mi (3,200km) IN-SEASON	END OF SEASON
2 - STROKE	<p><b>ENGINE OIL:</b> Fill to Recommended Level</p> <p><b>GENERAL LUBRICATION:</b> All Fittings, Pivots, Cables, etc.</p> <p><b>CHECK FOR WEAR:</b> Test, Clean &amp; Check Fluid Levels Spark Plugs, Track, Slider, Drive Belt &amp; Carbides</p>	<p><b>ENGINE OIL:</b> Fill to Recommended Level</p> <p><b>DRIVE BELT:</b> Inspect &amp; Adjust Follow Break-In Procedure After Installation</p> <p><b>TRANSMISSION FLUID:</b> Change</p>	<p><b>ENGINE OIL:</b> Fill to Recommended Level</p> <p><b>CHECK FOR WEAR:</b> Test, Clean &amp; Check Fluid Levels Spark Plugs, Track, Slider, Drive Belt &amp; Carbides</p> <p><b>DRIVE BELT:</b> Inspect &amp; Adjust Replace as Needed</p>	<p><b>DRIVE BELT:</b> Remove Consult Owner's Manual</p> <p><b>FUEL:</b> Add Fuel Stabilizer</p> <p><b>TRACK:</b> Inspect Reduce Tension During Storage</p> <p><b>BATTERY:</b> Remove</p>
4 - STROKE	<p><b>ENGINE OIL:</b> Fill to Recommended Level</p> <p><b>GENERAL LUBRICATION:</b> All Fittings, Pivots, Cables, etc.</p> <p><b>CHECK FOR WEAR:</b> Test, Clean &amp; Check Fluid Levels Spark Plugs, Track, Slider, Drive Belt &amp; Carbides</p>	<p><b>ENGINE OIL:</b> Change Oil &amp; Filter Follow Break-In Procedure</p> <p><b>DRIVE BELT:</b> Inspect &amp; Adjust Follow Break-In Procedure After Installation</p> <p><b>TRANSMISSION FLUID:</b> Change Follow Break-In Procedure</p>	<p><b>ENGINE OIL:</b> Fill to Recommended Level</p> <p><b>CHECK FOR WEAR:</b> Test, Clean &amp; Check Fluid Levels Spark Plugs, Track, Slider, Drive Belt &amp; Carbides</p> <p><b>DRIVE BELT:</b> Inspect &amp; Adjust Replace as Needed</p>	<p><b>ENGINE OIL:</b> Change Oil &amp; Filter (annually or every 4,000 mi / 6,437 km)</p> <p><b>DRIVE BELT:</b> Remove Consult Owner's Manual</p> <p><b>FUEL:</b> Add Fuel Stabilizer</p> <p><b>TRACK:</b> Inspect Reduce Tension During Storage</p> <p><b>BATTERY:</b> Remove or Connect Trickle Charger</p>

# FOR THE LIFE OF YOUR RIDE, ONLY THE BEST WILL DO

Top reliability and performance are the most important factors in Polaris Engineered Lubricants. Polaris Engineered Lubricants are engineered alongside the ever-evolving technology of Polaris high-performance engines to ensure you get an oil that is perfectly matched for your machine. Thousands of hours of testing every fluid in every engine design so you are getting the best product to keep you on the snow with your engine running strong.



## LUBRICANTS DESIGNED FOR RELIABILITY AND PERFORMANCE

The latest engine technologies need to be matched with the latest lubricant technology. Only Polaris Engineered Lubricants are designed and tested along with new Polaris engine technologies including turbocharged 2-stroke snowmobile engines, and 4-stroke snowmobile engines.

**12 DEDICATED**  
TEAM MEMBERS

**FOCUSED ON**  
POLARIS OIL

**1,000+**  
HOURS

**DYNO TESTING**

**18+**  
MONTHS

**DEVELOPMENT**  
& TESTING

**40,000 / 64,374**  
MILES / KILOMETERS

**FIELD TESTING**

## OIL DEVELOPMENT

POLARIS INVESTS IN EACH OIL AT AND ABOVE THESE LEVELS.



## KEY POINTS OF PROTECTION

### PISTON

Pistons play a critical role in engine operation and the wrong oil can lead to power loss, scuffing and poor performance.

- Maximizes power output while providing excellent film retention to prevent scuffing
- Superior stability in high temperatures, while minimizing carbon deposits and increasing long term reliability
- Oil flows at low temperatures to prevent hard starting



### CRANKSHAFT BEARING

Provides hydrodynamic barrier on bearing interfaces to extend upper and lower rod bearing life.

- Provides accurate oiling under extreme cold conditions
- Excellent film retention and heat transfer properties
- Corrosion inhibitors protect during off-season storage

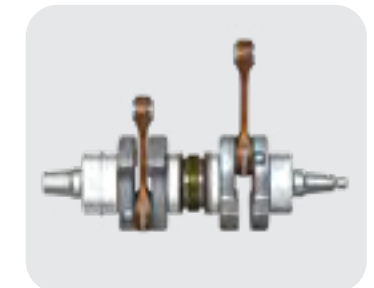

### EXHAUST VALVE OPERATION

Exhaust valves control power output during on and off throttle use. Improper lubricants can cause carbon buildup and sticking of valves, reducing power.

- Provides detergency over the life of the exhaust valves
- Minimizes carbon buildup to ensure exhaust valves continue to move freely and keep the engine running at peak power
- Designed to provide smooth valve operation throughout the life of the engine





**POLARIS BLUE**

Synthetic-blend 2-cycle oil formulated for reliable protection in all non-exhaust valve (non-VES) 2-cycle applications.

**OUR FORMULATION**

- Semi-synthetic formula
- High lubricity
- Proprietary corrosion additive package

**YOUR ADVANTAGE**

- Easier cold starting
- Prevents rust and corrosion
- Reduces wear for dependable performance



PRE-MIX ENGINES



FAN-COOLED ENGINES

1 Quart 2882201    2.5 Gallon 2882204    55-Gallon Drum 2882205

1 Gallon 2882202    16-Gallon Drum 2882203    330-Gallon Tote 2882206

**VES**

Full synthetic formulation designed to improve exhaust valve performance and offer excellent engine protection.

**OUR FORMULATION**

- Full synthetic formula
- Proprietary anti-wear, corrosion and detergency-additive package
- Retains film on critical engine parts after hot shutdown

**YOUR ADVANTAGE**

- Approved for use in all non-turbo 2-cycle snowmobile engines
- Greater wear protection and cleaner burning with less deposits for maximum engine life
- Reduced cold start effort and wear



PRE-MIX ENGINES



FAN-COOLED ENGINES



NON-BOOST LIQUID COOLED ENGINES

1 Quart 2877882    2.5 Gallon 2877884    55-Gallon Drum 2877886

1 Gallon 2877883    16-Gallon Drum 2877885    330-Gallon Tote 2877892

**VES EXTREME**

Ultimate full synthetic formulation to meet the demands of the highest performance engines including turbo-charged 2-cycle snowmobile engines in the most extreme conditions.

**OUR FORMULATION**

- Extreme full synthetic, 100% PAO and Ester formulation
- Highest engine film strength and lubricity protection
- Next generation proprietary anti-wear, corrosion and detergency additive system

**YOUR ADVANTAGE**

- Best engine-wear protection
- Maintains highest engine performance
- Ultimate cold weather starting performance and protection
- Cleanest engine components



NON-BOOST LIQUID COOLED ENGINES



BOOST ENGINES



RACING



EXTREME COLD

1 Quart 2883733    16-Gallon Drum 2883734    330-Gallon Tote 2883736

1 Gallon 2883732    55-Gallon Drum 2883735

**PS-4 EXTREME 0W-50**

Ultimate full synthetic 4-cycle formulation approved for use in all 4-cycle snowmobile engines.

**OUR FORMULATION**

- Extreme full synthetic base oils - PAO and Ester
- Widest viscosity range 0W-50 protects from below -45°F (-43°C) to over 130°F (54°C)
- Moly-boost, ZDDP and Clean Engine additives

**YOUR ADVANTAGE**

- Highest performance in the most extreme conditions
- Ultimate cold weather starting performance and protection
- Outstanding engine wear protection for best reliability



EXTREME COLD



FOUR STROKE

1 Quart 2889395    16-Gallon Drum 2889397    330-Gallon Tote 2889399

1 Gallon 2889396    55-Gallon Drum 2889398

REGULAR MAINTENANCE IS THE KEY TO KEEPING YOUR SNOWMOBILE  
**RUNNING LONGER, RIDING SMOOTHER,  
 AND LOOKING SHARPER.**

**OIL CHANGE KIT FOR 4-STROKE S4 ENGINE**

This Convenient kit includes everything needed including filter and oil volume for your vehicle

2890884



EXTREME COLD



FOUR STROKE

**OUR FORMULATION**

- Extreme full synthetic base oils - PAO and Ester
- Widest viscosity range 0W-50 protects from below -45°F (-43°C) to over 130°F (54°C)
- Moly-boost, ZDDP and Clean Engine additives

**YOUR ADVANTAGE**

- Highest performance in the most extreme conditions
- Ultimate cold weather starting performance and protection
- Outstanding engine wear protection for best reliability

# ENGINEERED TO MAXIMIZE THE LIFE OF YOUR RIDE

All Polaris fluids, from antifreeze to brake fluid, are developed for your vehicle. Trust the only fluids perfectly engineered for your needs.



## CARBON CLEAN

Ultimate fuel and injection system cleaner  
12 Ounce | 2881413



## SYNTHETIC CHAINCASE LUBE

Maximum performance and reliability, engineered for wear, rust and corrosion protection of high-speed, high-temp chains and sprockets  
1 Quart | 2873105  
1 Gallon | 2873106  
2.5 Gallon | 2872952



## ANTIFREEZE

Prevent corrosion on metal components, eliminate scaling, and maximize cooling system performance  
1 Quart | 2880514  
1 Gallon | 2880513  
55-Gallon Drum | 2880512



## DOT 4 BRAKE FLUID

A high-quality brake fluid designed for use in Polaris hydraulic brakes  
12 Ounce | 2872189



## OIL

Oil providing outstanding protection and proven performance  
Polaris Blue | Quart | 2882201  
VES | Quart | 2877882  
VES Extreme | Quart | 2883733  
PS-4 Extreme | Quart | 2889395



## ALL-SEASON GREASE

Exclusive all-season grease designed to protect and lubricate in harsh conditions and extreme temperatures  
3 Ounce 4-pack | 2871322  
14 Ounce | 2871423



## ADVANCED FUEL TREATMENT

- New advanced formula with 5:1 treat ratio
- Dual Antioxidant formula protects jets and fuel system from gum and varnish
- Stabilizes fuel for up to 2 years
- Alcohol free: safe for all powersports applications

12 Ounce | 2881416



## SHOCK OIL

Specialized fluids to ensure proper gas shock absorber action and fade resistance under extreme conditions  
Walker Evans Racing | 1 Quart | 2874522  
Premium FOX® | 1 Quart | 2870995  
Premium FOX® | 2.5 Gallon | 2872279



## FOGGING OIL

Eliminates rust and corrosion on internal engine parts during out-of-season storage  
12 Ounce | 2870791



## OIL CHANGE TOOL KIT

- 6.5 QT drain pan, one pint oil funnel with screen, oil filter wrench\*, 15" x 18" absorbent pads (2), clean up wipe (1), 6 mil nitrile gloves (1 pair), blue interfold shop towels (4)

2830545  
\*OIL FILTER WRENCH NOT COMPATIBLE WITH S4 4-STROKE ENGINE



## PUMP

- Fits 1 and 2.5 gallon bottles

2870465



## GREASE GUN

- Enables easy application of grease

3 oz | 2871312  
FOR 3 OZ ALL-SEASON & U-JOINT



## FLUID SYRINGE

- Easily add and remove fluid from your vehicle

2830553



## POLARIS LED POCKET FLASHLIGHT

Black | 2830436



## WORK LIGHT - 550 LUMENS

- UV and dual-charging on a 360° rotating swivel

2830584



## FOLDING WORK LIGHT - 2000 LUMENS

- Rechargeable light with 2 LED light heads and 360° magnetic swivel handle that functions as a stand

2830591



## PREMIUM MAINTENANCE TOOL KIT

- Includes 51 pieces for maintaining your Polaris machine
- Lifetime warranty on select tools

2830565



## POLARIS SHOP TOWELS

200 ct with dispenser | 2830402  
200 ct refill | 2830403  
64 ct refill | 2830440



## GREASE GUN

- Comfort grip handle and heavy-duty follower spring for high pressure applications and easy priming

14 oz | 2830569  
FOR 14 OZ ALL-SEASON & U-JOINT



## FLUID TRAY

- Holds up to 8 quarts of fluid

2830551



## POLARIS 33" TELESCOPIC MAGNET

Black | 2830435



## WORK LIGHT - 1000 LUMENS

- Adjustable with magnetic ends
- Battery charge indicator

2830585



## BATTERY OPERATED FLUID TRANSFER PUMP WITH FLOW CONTROL NOZZLE

- Ideal for quick transfer of fluid, diesel, DEF/Adblue, water & water based media
- Handheld flow control nozzle
- Powered by two 'D' batteries (not included)

2830595



## SNOW DOLLY

- 3" big-wheel caster design
- Move your sled around the garage with ease

2882959



## FLEX SPOUT

- Fits all Polaris quart, gallon and 2.5 gallon bottles

2871285



## FLUID FUNNEL

- Easily add oil with high accuracy

2830552



## POLARIS MAGNETIC PARTS TRAY

Silver | 2830432



## POLARIS 12" HI-TORQUE RATCHETING DRIVER

Black/Blue | 2830434



## WORK LIGHT - 4000 LUMENS

- 90° swivel LED light
- 16 FT, 14 gauge extension cord cable reel
- Magnetic backing

2830586



## BATTERY OPERATED FLUID TRANSFER PUMP

- Liquid transfer pumps 5-6 quarts/min suctioning power
- Powered by two 'D' batteries (not included)

2830513



# POLARIS ENGINEERED DRIVE BELTS

FIND THE RIGHT BELT FOR YOUR MACHINE IN OUR ONLINE PARTS CATALOG AT [POLARIS.COM](http://POLARIS.COM)



## OUR INVESTMENT PER BELT

- 20,000 miles (32,187 kilometers) of field testing
- Thousands of dyno hours
- 18+ months of development (3,000+ design hours) per belt
- 1,200+ vehicle validation hours
- Collaboration with powertrain and clutch engineers

## YOUR ADVANTAGE

- No clutch recalibration
- Less wear and tear due to heat
- Ensure maximum performance of your vehicle
- More time out riding, less time wrenching

BELT COMPOUND & CONSTRUCTION NOTES	BELT WIDTH*	OUTER CIRCUMFERENCE*	PART NUMBER
<b>MATRYX/AXYS: RMK, RUSH, SWITCHBACK (ALL), VOYAGEUR, TITAN, INDY (ALL)</b>			
High Modulus Chloroprene Belt	1.39" (35.18mm)	45.16"	3212348 (PRO STAR S4 / PATRIOT BOOST INDY / SWITCHBACK / PATRIOT 9R)
High Modulus Chloroprene Belt	1.46" (37.10mm)	45.16"	3211215 (2020-LATER 800 CLEANFIRE H.O / 850 PATRIOT)
PBO Belt	1.46" (37.10mm)	45.16"	3211177 (800 CLEANFIRE H.O. / 650 PATRIOT)
PBO Belt	1.46" (37.10mm)	45.16"	3211165 (600 CLEANFIRE / 650 PATRIOT / PROSTAR S4)
<b>MATRYX/AXYS: PRO-RMK, RMK ASSAULT, SKS &amp; KHAOS RMK</b>			
High Modulus Chloroprene Belt	1.46" (37.10mm)	46.77"	3211216 (2020-LATER 800 CLEANFIRE / 850 PATRIOT / PATRIOT BOOST / PATRIOT 9R)
PBO Belt	1.46" (37.10mm)	46.77"	3211183 (800 CLEANFIRE H.O.)
PBO Belt	1.46" (37.10mm)	46.77"	3211115 (600 CLEANFIRE / 650 PATRIOT)
<b>PRO-RIDE: RUSH, SWITCHBACK, SWITCHBACK ASSAULT, INDY, VOYAGEUR, PRO-RMK, RMK, RMK ASSAULT</b>			
PBO Belt	1.46" (37.10mm)	46.77"	3211115
KEVLAR® Belt	1.46" (37.10mm)	46.77"	3211122
KEVLAR® Belt	1.29" (32.77mm)	42.72"	3212350 (550 LIBERTY)

\*Belt dimensions are given in nominal dimensions. There is a +/- variance for all critical dimensions. Clutch setup must be inspected when a new belt is installed and should be adjusted if necessary. The drive belt is an important component in the CVT system. In order to achieve maximum efficiency from the converter, drive-belt deflection (tension), clutch offset and alignment must be adjusted properly. See your service manual for further details on drive-belt measurement inspection.

## HD PARTS



All Polaris parts are developed and tested to help you get the most out of your ride. We're taking the passion of our riders to the next level with HD Parts.

### ENGINEERED AND DESIGNED FOR:

- Greater durability
- Enhanced performance
- Greater wear and tear capabilities
- Extreme conditions



### BRAKE PADS

Hayes race inspired PRT brake pads utilize proven technology and material that is warp resistant and provides a consistent feel in all temperature ranges and environments.

OE	HD
2204036	2209690
2205500	
2206251	

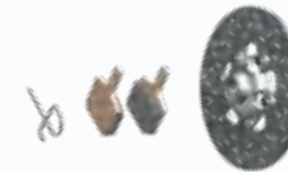

### BRAKE PAD KIT

Easily update the entire brake system with HD Pads (2209690) and Hayes Pro-Float 5R Rotor to provide maximum performance.

OE	HD
2205373	2209691
2206235	

LEARN MORE AT [POLARIS.COM/HDPARTS](http://POLARIS.COM/HDPARTS)

## BATTERY CHARGERS



### NOCO GENIUS® BATTERY CHARGER – 1 AMP

- Keep your battery charged
- Includes Boost Eyelet Cable with X-Connector Adapter (2830546)

2830567



### NOCO GENIUS® BATTERY CHARGER – 2 AMP

- Keep your battery charged
- Includes Boost Eyelet Cable with X-Connector Adapter (2830546)

2830568



### **NEW** NOCO GENIUS® BATTERY CHARGER – 5 AMP, 2 BANK

- Waterproof charger
- 5 amps per bank for charging any 12v, AGM, lead-acid and/or lithium-ion batteries

2830599



### **NEW** NOCO GENIUS® BATTERY CHARGER – 10 AMP, 4 BANK

- Waterproof charger
- 10 amps per bank for charging any 12v, AGM, lead-acid and/or lithium-ion batteries

2830601



### NOCO BOOST® GB40 12V 1000 AMP JUMP STARTER

- Delivers 1,000 amps for jump starting a dead battery in seconds

2830547



### **NEW** NOCO BOOST® GB70 12V 2000 AMP JUMP STARTER

- Delivers 2,000 amps for jump starting a dead battery in seconds

2830597



### NOCO BOOST® JUMP PACK PROTECTION CASE

- Lightweight, durable and rugged custom exterior

GB40 • 2830548

**NEW** GB70 • 2830598

YOUR BATTERY **IS READY** WHEN YOU ARE

# POLARIS POWER

BACKED BY A



WARRANTY



## TRY THE POLARIS MOBILE APP

COMPATIBLE WITH P2500iEBT & P3200iEBT

- Start & Stop Generator
- Monitor Fuel Level (with Low Fuel Warning), Output Percentage, Total Hours, Power Output
- Monitor Total Run Time Remaining, AC Wattage, AC Voltage, Engine, RPM & Engine Temperature
- Access Service & Owners Manual

### P2000i Inverter Generator 2830532



BEST USED FOR



Tailgating Off-Grid Camping



Extension Cord Management

### P2500iEBT Inverter Generator 2830537



CO  
DETECTION  
AUTO SHUT-OFF

BEST USED FOR



Tailgating Off-Grid Camping

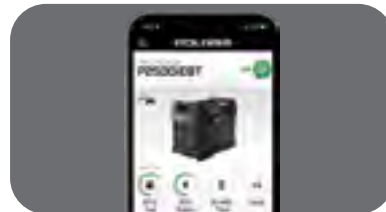

Polaris Mobile/App Compatible for Digital Gauge Readings and Remote Start Features

### NEW P3200iEBT Inverter Generator 2830539



CO  
DETECTION  
AUTO SHUT-OFF

BEST USED FOR



DIY Remodeling One Room Backup RV'ing

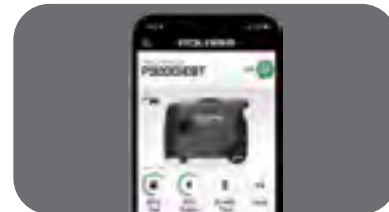

Polaris Mobile/App Compatible for Digital Gauge Readings and Remote Start Features

### P5500 / P6500 Open Frame Generator 2830534 / 2830535



BEST USED FOR



Construction Home Backup RV'ing



Rough Terrain Wheel

Electric Start

### PRESSURE WASHER 3700 2830573



- 3700 psi at 2.5 gpm
- Simpson pro-axial cam pump
- CRX 4-stroke 225cc OHV engine
- Low oil shut-down system
- 10" pneumatic tires
- Heavy-duty steel engine plate
- 1.25" tubular construction
- Professional spray gun
- 35' Morflex® hose
- Thermal relief valve

### NEW ELECTRIC PRESSURE WASHER 2500 2830592



- 2500 psi at 1.5 gpm
- 120v electric induction motor
- Axial pump with thermal relief valve
- Detachable cart for easy transport
- Professional spray gun with quick connect nozzles
- 25' Morflex® hose
- 8" Never-flat tires

## FEATURED ACCESSORIES



### SMALL ENGINE OIL

- 4-cycle engine oil
- 2879383



### ALL WEATHER COVER

P2500iEBT | 2830540  
P3200iE / P3200iEBT | 2830541  
P5500/P6500 | 2830542



### HIGH ALTITUDE MODIFICATION KIT

P2500iEBT | 2889540  
P3200iE / P3200iEBT | 2884866



### INVERTER PARALLEL KIT

- Parallel to any two Polaris inverter generators
- 2830536



### BATTERY OPERATED FLUID TRANSFER PUMP WITH FLOW CONTROL NOZZLE

2830595



### TURBO NOZZLE

- 3700 PSI .25" QC turbo nozzle delivers a strong jet of oscillating water that cleans faster than standard nozzles
- Made for reliability and durability, this nozzle is easy to use and great at cleaning hard to remove dirt and debris

2830579

VISIT [POLARISPOWER.COM](http://POLARISPOWER.COM)  
FOR MORE DETAILS

GARAGE

MAINTENANCE

OIL

LUBRICANTS &  
GARAGE ACCESSORIES

BELTS, HD PARTS &  
BATTERY CHARGERS

POLARIS POWER

SERVICE PARTS

# POLARIS ENGINEERED SERVICE PARTS

## DELIVER UNMATCHED PERFORMANCE AND FIT FOR YOUR SLED.



OVER  
**100,000**  
PARTS AVAILABLE!

Find helpful links, articles, and maintenance parts information. ACCESS THE POLARIS HELP CENTER AT POLARIS.COM

Our engineers at Polaris create snowmobile parts that push the limits of weight versus strength. We build our parts to feel lighter without sacrificing strength and durability. But over time, your sled will eventually need some service. When we're engineering our high-performance components, we keep serviceability in mind. From a quick clutch inspection to a ski alignment, we build our products as a system, so that anyone with the right tools and training can easily maintain their vehicle—and get back on the trails where your snowmobile belongs.



CHECK OUT OUR **PARTS FINDER ON POLARIS.COM** FOR EASY PARTS LOOK UP, PARTS IDENTIFICATION, VIEWS OF ASSEMBLIES & MORE!

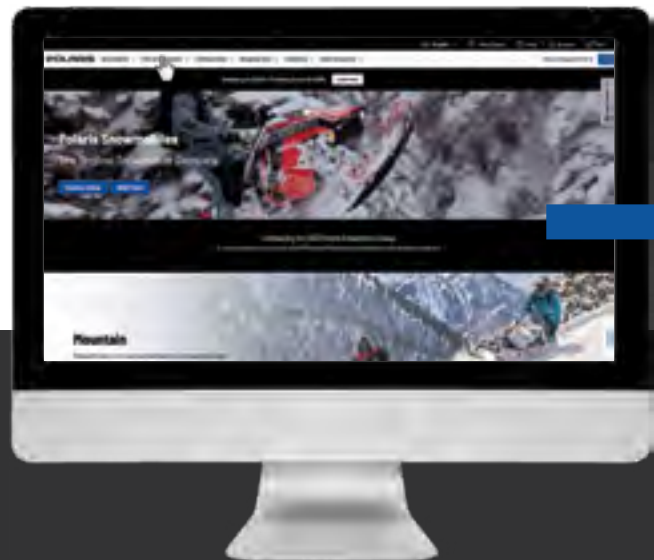

**STEP 1**

Visit [snowmobiles.polaris.com](http://snowmobiles.polaris.com)  
Click "Parts & Accessories" tab  
Click "Parts, Oil & Maintenance"



**STEP 2**

Enter **vehicle year/model** then **select the part**



**STEP 3**

Clearly see what parts are required and **order**

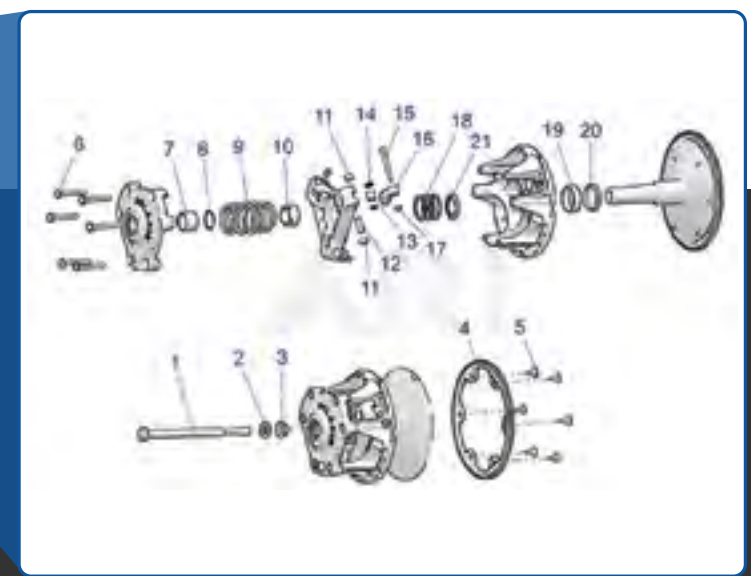

SHOP FOR SERVICE PARTS ONLINE OR VISIT YOUR POLARIS DEALER



# APPAREL

## FIT FOR ANY ADVENTURE.

For outdoor enthusiasts looking for gear that's purposefully built to stand up to the fun and challenging experiences Polaris vehicles enable. Each piece of apparel and equipment bearing the Polaris name is crafted by outdoor enthusiasts, for outdoor enthusiasts. They are a badge of honor—representing what the Polaris brand stands for—a passion to simply be outside doing what you love. Polaris Apparel is rider-inspired and tested under real-world extremes so it's ready for anything the outdoors will throw at it.

### APPAREL CONTENTS

- 88 Riding Gear 101
- 90 TECH54
- 92 Men's Apparel
- 110 UNRL® x Polaris
- 112 Polaris Heated Apparel
- 114 Women's Apparel
- 126 Youth Apparel
- 130 Helmets
- 140 Goggles
- 142 Rider Safety
- 146 Hats
- 148 Gloves
- 150 Boots, Balaclavas & Luggage
- 152 Home & Collectibles



**TECH54**



# DESIGNED BY RIDERS FOR RIDERS

Polaris Engineered Riding Gear is high-quality outdoor gear designed for a wide range of riders, riding styles and other outdoor activities. It is intentionally designed to work together as a smart solution with the best fit and optimal comfort so that you can stay out longer, doing what you love.



## HELMET

**FACE THE DAY WITH CONFIDENCE.**  
The ideal snowmobile helmet will offer proper fit, all-day comfort and personal style—to inspire confidence when you're out there carving powder.

## GOGGLES

**EVERY DAY. ANY CONDITION.**  
We offer a range of styles to fit your look and lens color options to enhance your vision in virtually any light condition you'll encounter—helping you pick out obstacles earlier and reduce eye strain.

## JACKET **TECH54**

**OWN THE EXTREMES.**  
All of our riding jackets are purpose built by our own team of technical experts to provide cold weather comfort, flexibility and a wide range of motion. Select the jacket that is best for your riding conditions with the right amount of warmth and breathability.

## BIBS **TECH54**

**LIVE IN YOUR ELEMENT.**  
Warmth, comfortable fit, and flexibility are key in choosing the right bibs. Polaris bibs provide a wider range of motion in the knees, thighs and waist to move with you as you ride.

## TECH54

Every Polaris riding jacket, bib, monosuit and boot is made with TECH54, an exclusive technology from Polaris. TECH54 is a waterproof and breathable membrane that locks out moisture, and lets body vapor escape, to keep you warm, dry and comfortable. Visit P. 90 to learn more.

## BALACLAVA

**SHIELD THE ELEMENTS.**  
Keep your face and neck protected from harsh conditions with a balaclava. These are intentionally designed to keep you warm and comfortable with windproof material and an anti-fog design.

## LAYERING

**LAYER ON THE WARMTH.**  
Choose the right layers for your conditions. Start with our moisture-wicking base layers to help maintain proper body temperature, then add middle insulating or a heated layer depending on the weather.

## GLOVES

**GRAB HOLD OF THE ADVENTURE.**  
All Polaris Engineered gloves are designed to keep the bitter cold out using a powerful combination of insulated materials and moisture-wicking linings while giving you a firm, confident grip on any situation.

## BOOTS **TECH54**

**PERFORMANCE, WARMTH AND COMFORT.**  
Cold feet ruin more snowmobile rides than anything else. Stay warm and dry all day with the Switchback 2.0 Boot which features hypergrip traction and a BOA® lacing system for easy on and off.



## RIDER SAFETY **PIEPS**

**AVALANCHE SAFETY EQUIPMENT  
CRITICAL FOR MOUNTAIN RIDERS.**

See P. 142 for more information.

# THE RIGHT GEAR FOR HOW YOU RIDE.

Riding gear specifically designed for your riding style with different levels of warmth, breathability and versatility. Find the best gear for you based on the type of riding you do most. Ride in style with colors that match your sled and your personality.

Scan the QR codes below to explore the full lineup.



## TRAIL GEAR

Insulated riding gear with exceptional warmth and minimal bulk

Men's Northstar Jacket	P. 98
Men's Northstar Bib	P. 98
Men's Traveler Jacket	P. 99
Men's Traveler Bib	P. 99
Women's Northstar 2.0 Jacket	P. 118
Women's Northstar 2.0 Bib	P. 119
Men's Northstar Glove	P. 148
Men's Titan Leather Glove	P. 148
Women's Northstar Glove	P. 148



## CROSSOVER GEAR

Versatile riding gear for any condition

Men's Switchback 2.0 Jacket	P. 96
Men's Switchback Bib	P. 97
Women's Switchback 2.0 Jacket	P. 117
Women's Switchback Bib	P. 117
Switchback Glove	P. 149



## MOUNTAIN GEAR

Uninsulated and breathable gear for aggressive riding

Men's Teton Jacket	P. 94
Men's Teton Bib	P. 94
Men's Teton Monosuit	P. 95
Women's Teton Jacket	P. 116
Women's Teton Bib	P. 116
Teton Glove	P. 149



# TECH54

## TECHNOLOGY TO OWN THE EXTREMES

STAY WARM AND DRY IN RIDING GEAR WITH TECH 54.

Our Apparel Center of Excellence developed TECH54—a waterproof, breathable membrane featured in every Polaris jacket, bib and monosuit. This exclusive technology allows perspiration to escape and keeps water out, so no matter how you ride, or where you ride, you stay dry, warm and comfortable.



### WATERPROOF/BREATHABLE

TECH54 is our single-layer bonded laminate technology that brings waterproof breathability and riding comfort to a new level in every Polaris jacket and bib.

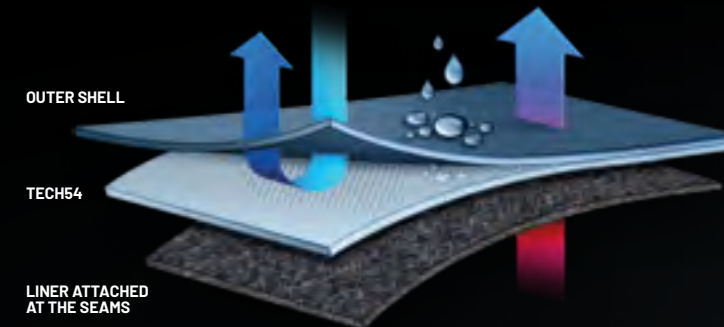

### DWR

#### RESIST MOISTURE

Every Polaris jacket and bib is treated with a DWR (Durable Water Repellent) coating to prevent precipitation from saturating the outer fabric, so your gear doesn't get soggy. The DWR coating causes water to bead up and run off, keeping you comfortable and dry.

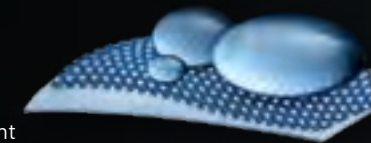

### 3M Scotchlite™ Reflective Material

#### RIDE SAFER

Proven in every weather condition, patented 3M® Scotchlite® Reflective Material is placed meticulously on each garment and nighttime tested to provide visibility from every angle.

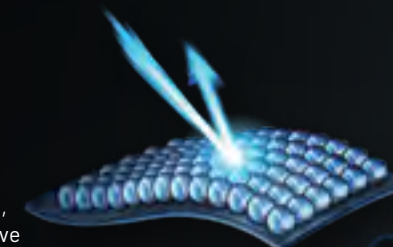

### YKK ZIPPERS

#### STAY PROTECTED

Quality construction you can trust.

### 3M Thinsulate™ INSULATION

#### BE WARMER

3M® Thinsulate® Insulation is zonally mapped on insulated apparel to provide extra insulation in high wind exposure areas.



### HOW IT WORKS TO ELEVATE YOUR RIDE.

5k/5k, 10k/10k OR 20k/20k

#### WATERPROOF

The first number (5k, 10k or 20k) refers to the waterproof rating.

#### BREATHABILITY

The second number (5k, 10k or 20k) refers to how much water vapor the material can expel through the outerwear to release heat—and keep you dry from the inside.

#### DIFFERENT RATINGS FOR DIFFERENT RIDES

Choose your TECH54 rating based on the weather conditions and your level of exertion.

**5k/5k:** best for colder and drier snow conditions and moderate activity.

**10k/10k:** best for wet snow conditions and high-activity riding.

**20k/20k:** best for extremely wet snow conditions and the most aggressive riding.



DIVE DEEPER INTO TECH54 AT [POLARIS.COM/TECH54](https://www.polaris.com/tech54)



# MEN'S RIDING GEAR

Our innovative designs and advanced technical materials keep you warm, dry, and happy - head to toe - on every ride. TECH54 jackets, bibs, and monosuits provide ultimate protection and comfort for every type of rider. And our helmets offer styles, designs, and features just right for the way you ride.

# LAYERING

Anyone can layer up. But the key to staying warm and comfortable is picking the right layers for the conditions. Start with our moisture-wicking base layers to help maintain proper body temperature, then add a middle insulating or heated layer depending on the conditions.



# LIFESTYLE

Polaris hats, tees and jackets show others how you choose to live your life. This is well-crafted clothing that's purpose-built to keep you comfortable outdoors—right where you want to be.





**TECH54**



**DARK TEAL**  
2865304



**LIGHT GRAY**  
2865303



**BLACK**  
2865302

S-3XL | MT-2XLT  
AVAILABLE IN TALL



**BLACK**  
2865305

AVAILABLE IN TALL

**20K/20K**

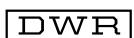

**3M Scotchlite™**  
Reflective Material

**YKK™**  
ZIPPERS

# NEW TETON

## JACKET

ADVANCED UNINSULATED JACKET WITH PREMIUM NEW FEATURES OFFERING MAXIMUM WATERPROOFNESS AND BREATHABILITY

S-3XL  
UNLESS NOTED

- Three-layer stretch woven fabric for ultimate freedom of movement
- Features TECH54 Pro bonded internal laminate with 20k/20k properties
- Outer shell is treated with PFC-free DWR coating to shed snow and water
- Four external pockets (two hand, one chest and one sleeve pocket) plus an internal goggle/glove storage pocket
- Flow through ventilation with front and back vents to keep you cool
- Internal hand gaiters, integrated snow skirt and an adjustable, removable hood keep snow out and allow for maximum versatility
- Highly visible in low light conditions with 3M® Scotchlite® Reflective Material

WARMTH

BREATHABILITY

VERSATILITY

UNINSULATED

## BIB

ADVANCED UNINSULATED BIB WITH PREMIUM NEW FEATURES OFFERING MAXIMUM WATERPROOFNESS AND BREATHABILITY

S-3XL, MT-2XLT

- Three-layer stretch woven fabric for ultimate freedom of movement
- 600 denier reinforcements at knees, scuff guards and hems along with built-in kneepads for ultimate protection
- Features TECH54 Pro bonded internal laminate with 20k/20k properties
- Outer shell is treated with PFC-free DWR coating to shed snow and water
- One chest pocket and two thigh pockets (one with beacon tether)
- Articulated knees, waist adjustment with pull tabs and stretch panels at side for premium comfort
- Highly visible in low light conditions with 3M® Scotchlite® Reflective Material

WARMTH

BREATHABILITY

VERSATILITY

UNINSULATED



**TECH54**



**GRAY/BLUE**  
2865300



**BLACK/LIME**  
2865301

**20K/20K**



**3M Scotchlite™**  
Reflective Material

**YKK™**  
ZIPPERS

# NEW TETON MONOSUIT

ADVANCED UNINSULATED MONOSUIT WITH PREMIUM NEW FEATURES ENABLES FREE RANGE OF MOTION AND PREVENTS SNOW INTRUSION TO KEEP YOU DRY AND COMFORTABLE

S-3XL

- One piece construction ensures snow stays on the outside
- Three-layer stretch woven fabric for ultimate freedom of movement
- Features TECH54 Pro bonded internal laminate with 20k/20k properties
- Outer shell is treated with PFC-free DWR coating to shed snow and water
- 600 denier reinforcements at knees, scuff guards and hems along with built-in kneepads for ultimate protection

- Four external pockets (one chest, two thigh - one with beacon tether and one sleeve) along with one internal glove/goggle pocket
- Internal elastic suspenders, adjustable waist tabs, internal hand gaiters and a removable/adjustable hood allow for maximum comfort and versatility

WARMTH

BREATHABILITY

VERSATILITY

UNINSULATED

## SUPERIOR VENTING

Flow-through venting at chest and back along with two thigh vents on the leg allow for maximum air flow to keep you cool when riding.

## IMPROVED MOBILITY

Action back for ease of movement and articulated fit for maximum mobility and comfort.

## CUSTOMIZED FIT

Adjustable waist tabs and internal suspenders for a comfortable and customized fit.





**TECH54**



**BLACK**  
2865306

**OLIVE/BLACK**  
2865307

**TEAL/LIME**  
2865308

**CABERNET/GRAY**  
2865309

**BLACK**  
2864503  
S-3XL | MT-2XLT  
AVAILABLE IN TALL

**GRAY**  
2864504

**10K/10K** **DWR** **3M Thinsulate INSULATION** **3M Scotchlite™ Reflective Material** **YKK ZIPPERS**

# NEW SWITCHBACK 2.0

JACKET

TRUE THREE-IN-ONE VERSATILITY WITH A DURABLE SHELL AND A NEW WEARABLE, REMOVABLE LINER

S-3XL

- Durable 300 denier polyester shell is tear and snag-resistant and treated with superior PFC-free DWR to shed snow and water from the outer shell
- Features TECH54 bonded internal laminate with 10k/10k properties
- Removable and wearable puffer liner with zonal 140g insulation in body and 100g in arms
- Shock-cord adjustable bottom hem to keep snow out
- Removable/adjustable hood
- Three external zippered pockets (two hand, one chest)
- Zippered underarm vents for increased versatility and comfort
- Highly visible in low light conditions with 3M® Scotchlite® Reflective Material

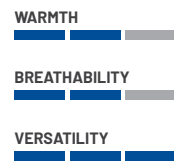

INSULATED



## MAXIMUM VERSATILITY

Remove the insulated liner without sacrificing waterproof breathability, while increasing versatility for changing ride conditions.

**10K/10K** **DWR** **3M Thinsulate INSULATION** **3M Scotchlite™ Reflective Material** **YKK ZIPPERS**

# SWITCHBACK

BIB/PANT

VERSATILE BIB FEATURES ZONAL INSULATION AND EASY CONVERSION TO PANTS

S-3XL  
UNLESS NOTED

- Durable 300 denier poly shell is tear- and snag-resistant and treated with superior DWR to shed snow and water from the outer shell
- Features TECH54 bonded internal laminate with 10k/10k properties
- Insulated with 120g insulation in front and 80g in back
- Two inner-thigh vents
- Two-way front zipper
- Storm cuffs with boot-lace retention snaps
- Removable suspenders allow bib to be converted to an adjustable waist pant
- Highly visible in low light conditions with 3M® Scotchlite® Reflective Material

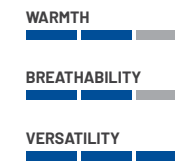

INSULATED





# TECH54



RETRO  
2864506



BLACK  
2833000

S-3XL | MT-2XLT  
AVAILABLE IN TALL



RED  
2864505



BLUE  
2833001



BLACK  
2833058

S-3XL | MT-2XLT  
AVAILABLE IN TALL

5k/5k



3M Thinsulate INSULATION

3M Scotchlite Reflective Material

YKK ZIPPERS

# NORTHSTAR

## JACKET

INSULATED JACKET PROVIDES GREAT WARMTH WITH MINIMAL BULK AT INCREDIBLE VALUE

S-3XL  
UNLESS NOTED

- Durable 300 denier poly shell is tear- and snag-resistant and treated with superior DWR to shed snow and water from the outer shell
- Features TECH54 bonded internal laminate with 5k/5k properties
- Insulated with 180g insulation in body and 100g in arms
- Shock-cord adjustable hem to keep snow out
- Highly visible in low light conditions with 3M® Scotchlite® Reflective Material

WARMTH

BREATHABILITY

VERSATILITY

INSULATED

## BIB

ZONAL INSULATION PROVIDES GREAT WARMTH WITH MINIMAL BULK AT AN INCREDIBLE VALUE

S-3XL, MT-2XLT

- Durable 300 denier poly shell is tear- and snag-resistant and treated with superior DWR to shed snow and water from the outer shell
- Features TECH54 bonded internal laminate with 5k/5k properties
- Insulated with 180g insulation in upper front of legs and lower back and 100g on upper backside
- Two-way front zipper
- Storm cuffs with boot-lace retention snaps
- Highly visible in low light conditions with 3M® Scotchlite® Reflective Material

WARMTH

BREATHABILITY

VERSATILITY

INSULATED

# TECH54



BLACK  
2865311

S-3XL | MT-2XLT  
AVAILABLE IN TALL



DARK BLUE/NAVY  
2865312



OLIVE/BLACK  
2865313



BLACK  
2865314

S-3XL | MT-2XLT  
AVAILABLE IN TALL

5k/5k



3M Thinsulate INSULATION

3M Scotchlite Reflective Material

YKK ZIPPERS

# TRAVELER

## JACKET

ADVANCED INSULATION WITH ENHANCED DURABILITY AND ULTIMATE STORAGE TO OUTLAST THE ELEMENTS

S-3XL  
UNLESS NOTED

- Durable 600 denier Cordura® outer fabric is tear- and snag resistant and treated with PFC-free DWR to shed snow and water from the outer shell to keep you dry
- Features TECH54 bonded internal laminate with 5k/5k properties
- Insulated with 300g insulation in body, 220g in arms and 100g in collar
- Ultimate storage featuring four external pockets (two large front cargo pockets and two zippered hand pockets) and a zippered interior pocket
- Shockcord adjustable hem, snow skirt and interior hand gaiters to keep snow out
- Highly visible in low light conditions with 3M® Scotchlite® Reflective Material

WARMTH

BREATHABILITY

VERSATILITY

INSULATED

## BIB

ADVANCED INSULATION WITH ENHANCED DURABILITY TO OUTLAST THE ELEMENTS

S-3XL, MT-2XLT

- Durable 600 denier Cordura® outer fabric is tear- and snag resistant and treated with PFC-free DWR to shed snow and water from the outer shell to keep you dry
- Features TECH54 bonded internal laminate with 5k/5k properties
- Insulated with 180g front and 100g back insulation plus thigh vents for comfort
- Reinforced at knees, seat and scuff guards for added durability
- Additional storage featuring two thigh pockets and one chest pocket
- Highly visible in low light conditions with 3M® Scotchlite® Reflective Material

WARMTH

BREATHABILITY

VERSATILITY

INSULATED

BASE & MID-LAYERS

Quick-drying and quick-wicking. Rests against your skin to regulate your overall body temperature by wicking away moisture. Insulating layers for the right level of warmth for your riding conditions.

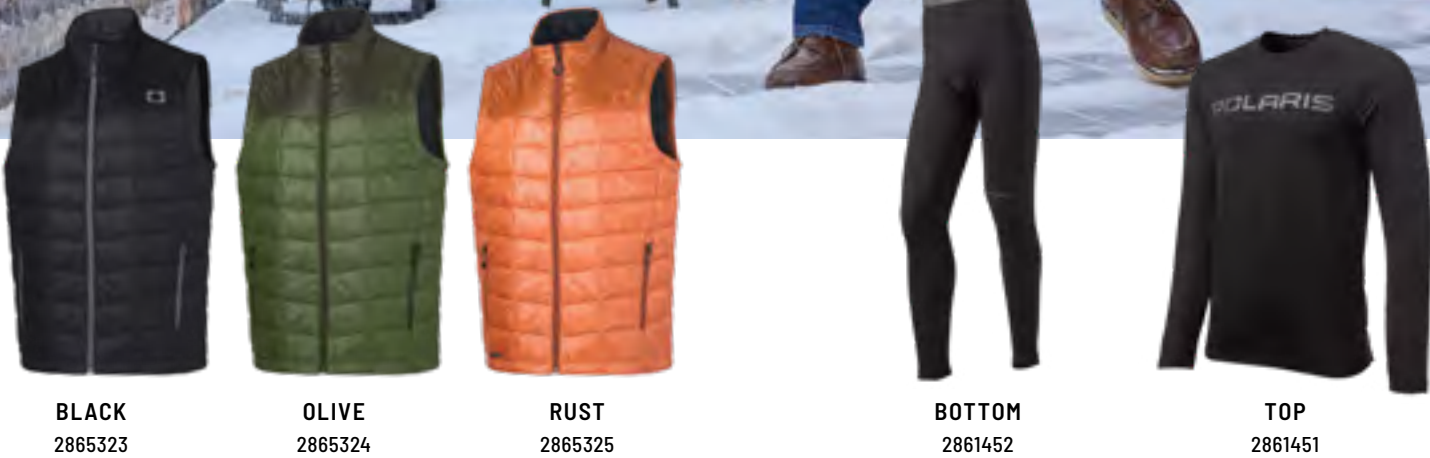

**BLACK**  
2865323

**OLIVE**  
2865324

**RUST**  
2865325

**BOTTOM**  
2861452

**TOP**  
2861451

**NEW**  
ROSEAU QUILTED VEST

VERSATILE LAYERING WITH CLASSIC PUFFER STYLING

S-3XL

- Durable polyester windbreak outer fabric helps protect from the elements
- 140g 3M® Thinsulate® Insulation keeps you warm in cold weather
- Classic color-block design and zippered hand pockets

MIDWEIGHT BASE LAYER

LIGHTWEIGHT, COMFORTABLE, MOISTURE-WICKING BASE LAYER

S-3XL

- Comfortable stretch fabric to allow for maximum movement
- 92% polyester, 8% spandex
- 220g fleece lined brushed fabric provides comfort and warmth



**BLACK**  
2865357

**SAND**  
2865358

**OLIVE**  
2865359

**BLACK**  
2865360

**GRAY**  
2865361

**BLUE**  
2865362

**NEW**  
TRAVELER HALF-ZIP MID-LAYER

EXTREMELY WARM AND VERSATILE MID-LAYER CAN BE WORN ALONE OR AS AN EXTRA LAYER

S-3XL

- 330g, 100% polyester anti-pilling sherpa fleece for added warmth
- Zippered chest and hand pockets for secure storage



**NEW**  
RANGE FULL-ZIP MID-LAYER

WARM AND BREATHABLE MID-LAYER, PERFECT FOR RIDING

S-3XL

- 330g, 100% polyester sweater-knit fleece with brushed fleece interior provides great warmth
- Cover-stitched seams for added durability
- Zippered side hand pockets for secure storage





**BLUE** 2864601    **BLACK** 2862522    **CYPRESS** 2864523    **DARK BLUE** 2864522    **ORANGE** 2833025    **GRAY** 2862576

**ROSEAU QUARTER-ZIP SWEATER**

CASUAL LOOK & FEEL AND IS PERFECT AS A LIGHT MID-LAYER **S-3XL**

- Wear this lightweight quarter-zip on a casual day to look and feel good
- A blend of cotton and polyester make this shirt comfortable to wear

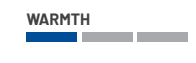

**TECH QUARTER-ZIP** ★ TOP SELLER

FLEECE LINED MID-LAYER FOR ESSENTIAL WARMTH WHILE RIDING WITH THE STYLE AND COMFORT TO WEAR ANYWHERE **S-3XL**

- Fleece-lining keeps you cozy and warm
- Move freely with four-way stretch material
- Contoured, slim fit



**GRAY** 2865355    **RUST** 2865356

**SWITCHBACK 2.0 MID-LAYER**

BATTLE THE COLD WITHOUT THE BULK AND SLIDE YOUR JACKET ON EASILY **S-3XL**

- 260g technical-face fleece made of a polyester/spandex blend enhances fit without restricting movement
- Zippered hand pockets for secure storage



**LIGHT GRAY** 2833110    **GRAY** 2862521    **NAVY** 2862523

**ADAPT QUARTER-ZIP**

EXTRA LIGHT MID-LAYER WITH A COMFORTABLE FIT **S-3XL**

- Versatile use both on and off the trail
- The polyester and spandex blend enables a flexible fit



**BLACK** 2865499

**KNIT JOGGER**

WARM & COMFORTABLE, PERFECT FOR RELAXING AFTER A DAY OF RIDING **S-3XL**

- 270g fleece with moisture-management and anti-pilling
- Two zippered pockets - one back and one side
- Athletic fit





**BLACK**  
2865318

**RUST**  
2865319

**BLUE**  
2865320

**NEW**  
**SOFTSHELL JACKET 2.0**

AN EVOLUTION OF STYLE AND PERFORMANCE FOR THE MODERN ADVENTURER

S-3XL

- Superior PFC-free DWR coating prevents precipitation from saturating the jackets exterior
- Lined with soft 125g fleece for warmth
- Shock-cord adjustable hood and bottom hem
- Two zippered hand pockets and one zippered chest pocket



**BLACK**  
2865315

**OLIVE**  
2865316

**BLUE**  
2865317

**NEW**  
**ROSEAU PACKABLE PUFFER JACKET**

PACKABLE JACKET OFFERS LIGHTWEIGHT PROTECTION AND INCREDIBLE WARMTH

S-3XL

- 140g 3M® Thinsulate® Insulation in body and arms, 100g insulation in hood
- Front zippered hand pockets
- Packs into left hand pocket for easy travel
- Classic color-block design

**NEW**  
**CABERNET/ORANGE**  
2865495

**BLUE**  
2864671

**CYPRESS**  
2864672

**PLAID FLANNEL SHIRT**

COMFORTABLE YET DURABLE WITH A CLASSIC FIT, PERFECT FOR ANY OCCASION

S-3XL

- Exclusive plaid design
- 100% cotton brushed flannel shirt
- Two pocket-shirt silhouette with additional left side-zip chest pocket



**BLACK**  
2865321

**TAN**  
2865322

**NEW**  
**RANGE WORK JACKET**

RUGGED AND WARM JACKET THAT'S TOUGH FOR WORK AND COMFORTABLE FOR PLAY

S-3XL

- Durable stretch canvas with PFC-free DWR coating prevents precipitation from saturating outer shell
- 60g 3M® Thinsulate® Insulation provides warmth without added bulk
- Front cargo pockets along with two side-zippered hand pockets and zippered chest pocket for maximum storage



**SAND**  
2865497

**CYPRESS**  
2865498

**NEW**  
**MEN'S PERFORMANCE SHIRT**

ULTRA-LIGHT AND BREATHABLE SHIRT FOR COOL COMFORT ALL DAY

S-3XL

- Quick-dry comfort with 50+ UPF protection rating
- Long sleeves easily convert to short sleeves with a button tab to secure
- Classic two pocket design with additional left side-zip chest pocket



**TEAM POLARIS IS PUSHING RACING TO THE LIMIT.**

Show your passion for the thrill with our lineup of Polaris Racing apparel.



**POLARIS RACING FULL ZIP HOODIE**  
S-3XL  
Black | 2864594

**MEN'S POLARIS RACING TEE**  
S-3XL  
**NEW** Blue | 2865440  
Black | 2864619

**NEW**  
**WOMEN'S POLARIS RACING TEE**  
S-3XL  
Black | 2865513

**POLARIS RACING BEANIE**  
Black | 2864700

**POLARIS RACING CAP**  
**NEW** Blue | S/M | 2865525  
**NEW** Blue | L/XL | 2865526  
Black | S/M | 2864714  
Black | L/XL | 2864581



BACK



**NEW**  
HEX GRAPHIC FULL-ZIP HOODIE

S-3XL  
Navy | 2865454  
Green | 2865455



**NEW**  
ODYSSEY HOODIE

S-3XL  
Gray | 2865394  
Tan | 2865395  
Navy | 2865396



**NEW** ★ TOP SELLER  
STAPLE HOODIE

S-3XL  
Rust | 2865456  
Blue | 2864605  
Black | 2833068  
Green | 2833070



★ TOP SELLER  
RETRO LOGO HOODIE

S-3XL  
Gray | 2864630  
Blue | 2864631  
Navy | 2833060



PURSUIT HOODIE

S-3XL  
Camo | 2862494  
Orange | 2864606  
Black | 2833076  
Green | 2833077



**NEW**  
TECH FULL-ZIP HOODIE

S-3XL  
Black | 2865507  
Olive | 2865508



★ TOP SELLER  
ICON HOODIE

S-3XL  
Dark Green | 2865453  
Red | 2864592  
Blue | 2864593  
Black/Red | 2833065  
Gray | 2862487



HERITAGE CREW NECK SWEATSHIRT

S-3XL  
Navy | 2864624



**NEW**  
SHADOW LOGO CREW SWEATSHIRT

S-3XL  
Black | 2865460  
Olive | 2865462



ICON EDGE LONG SLEEVE

S-3XL  
Gray | 2864682  
Blue | 2864683

RIGHT SLEEVE



**NEW**  
STACKED NEON LONG SLEEVE

S-3XL  
Heather Gray | 2865442  
Olive Heather | 2865443



UPF HOODIE TEE

S-3XL  
Olive | 2865492  
Blue | 2833072  
Gray | 2833073



**NEW**  
THINK OUTSIDE HOODIE

S-3XL  
Black | 2865458  
Cabernet | 2865459

BACK



ASCENT HOODIE

S-3XL  
Black | 2864677  
Gray | 2864678  
Red | 2864679



**NEW**  
GRADED BADGE LONG SLEEVE

S-3XL  
Blue | 2865447  
Red | 2865448



**NEW**  
PERFORMANCE LONG SLEEVE

S-3XL  
Dark Blue | 2865437  
Rust | 2865438  
Gray | 2865439



ICON LONG SLEEVE

S-3XL  
Black | 2861584  
Blue | 2864591  
Navy | 2864590



**NEW**  
**BACKCOUNTRY TEE**  
 S-3XL  
 Heather Gray | 2865464  
 Maroon Heather | 2865465



**EAT. SLEEP. BRAAAP. TEE** ★ TOP SELLER  
 S-3XL  
**NEW** Maroon Heather | 2865463  
 Heather Gray | 2864675  
 Black | 2864676



**HERITAGE TEE** ★ TOP SELLER  
 S-3XL  
 Heather Gray | 2864586  
 Navy | 2860573



**EVOLUTION TEE** ★ TOP SELLER  
 S-3XL  
 Blue | 2864613  
 Black | 2833088



**FLAG TEE** ★ TOP SELLER  
 S-3XL  
 Navy | 2862500  
 White | 2862582



**ASCENT TEE**  
 S-3XL  
 Olive | 2864680  
 Navy | 2864681



**LEGACY '54 TEE**  
 S-3XL  
 Red | 2864686  
 Blue | 2864687



**NEW**  
**OFF ROAD CANYON TEE**  
 S-3XL  
 Heather Gray | 2865445  
 Blue | 2865446



**GRAPHIC TEE**  
 S-3XL  
 Heather Gray | 2864612  
 Forest Green | 2833087



**NEW**  
**LIFE OUTSIDE TEE**  
 S-3XL  
 Faded Red | 2865450  
 Sage | 2865451  
 Light Blue | 2865452



**HALF DOME TEE**  
 S-3XL  
 Black | 2864616  
 Olive | 2864617  
 Navy | 2864618



**SHIELD TEE**  
 S-3XL  
**NEW** White | 2865441  
 Navy | 2864620



**NEW**  
**ICON TEE** ★ TOP SELLER  
 S-3XL  
 Maroon Heather | 2865436  
 Navy | 2864596  
 Red | 2864595  
 Green | 2862501  
 Black | 2861570



**PEAK GRAPHIC TEE**  
 S-3XL  
 Blue | 2864684  
 Black | 2864685



**THINK OUTSIDE TEE**  
 S-3XL  
 Blue | 2864634  
 Green | 2833080  
 Black | 2861567



**PIT SHIRT** ★ TOP SELLER  
 Cypress | XS-4XL | 2864561  
 Black | XS-4XL | 2862526  
 Navy | S-3XL | 2833043



**CORE POLO**  
 S-3XL  
 Black | 2861489  
 Navy | 2861490

# FEATURING UNRL® x POLARIS

UNRL® and Polaris have teamed up to create a unique, limited edition collaboration between two Minnesota brands featuring one-of-a-kind designs blending premium fit and performance with subtle color and sophisticated details. We set out to craft pieces that you'll reach for every day. Ready to outwork and outplay everything else in your closet.

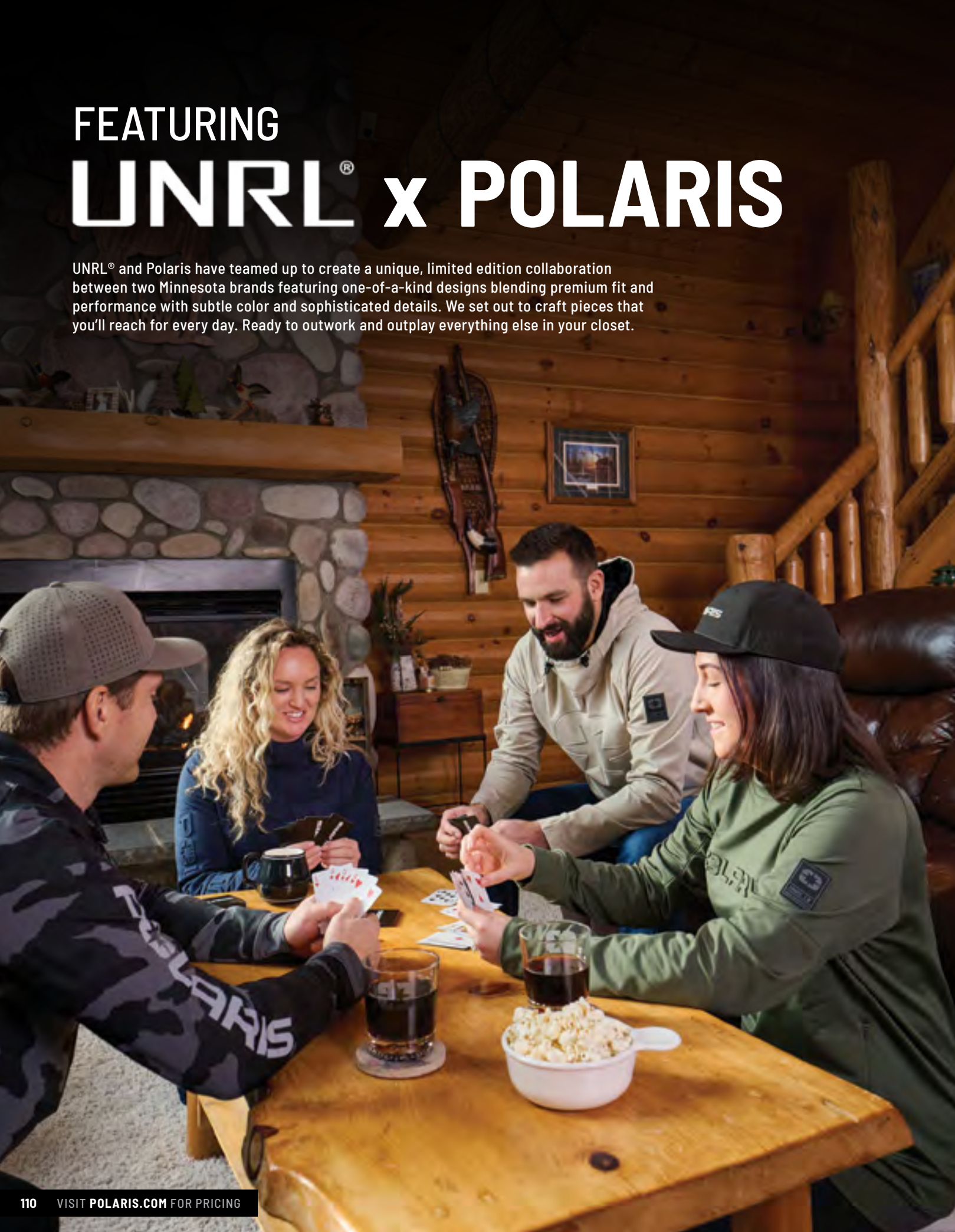

**NEW**  
**CROSSOVER HOODIE II**  
S-3XL  
Navy | 2865570  
Sand | 2865571  
Black Camo | 2865572



**NEW**  
**CROSSOVER CREWNECK**  
S-3XL  
Grove | 2865573  
Black | 2865574



**NEW**  
**HIGHLANDS QUARTER-ZIP**  
S-3XL  
Black | 2865575



**NEW**  
**LEGEND POLO**  
S-3XL  
Black | 2865578

**NEW**  
**TOPOGRAPHIC POLO**  
S-3XL  
Grove | 2865576  
Gray | 2865577



**NEW**  
**MID-PRO VENTED  
SNAPBACK CAP**  
Black | 2865579  
Sand | 2865580



**NEW**  
**ELITE WINTER  
KNIT BEANIE**  
Black | 2865581



# POLARIS HEATED APPAREL

Keep warm even on the coldest days with Polaris Heated Apparel. By keeping the heat close to your body, you can stay out longer on all your winter adventures. The Polaris Heated Apparel lineup includes the Heated Vest, Heated Base Layers, and a Heated Glove Liner for both men and women. Easily control your heat setting with the touch of a button.



### THE HEAT INDEX

	100%	75%	50%	25%
	100%	75%	50%	25%
	Up to 135° F	Up to 120° F	Up to 105° F	Up to 90° F
	Up to 2.0 Hrs.	Up to 3.0 Hrs.	Up to 4.0 Hrs.	Up to 8.0 Hrs.

NOTE: Heat and time are estimated and may vary depending on conditions. Exposing battery to cold temperatures may impact these estimates.

## THE HEATED ADVANTAGE

The Polaris Heated Apparel lineup features lightweight, moisture wicking fabric infused with stretch panels and a chafe free waistband to give you the most comfortable layering to wear on all of your cold weather adventures, on or off the trail.

Our lineup has multiple heat panels for evenly distributed heat for maximum warmth and comfort. Easily adjust between 4 heat settings for changing weather conditions with built-in buttons.



\* TOP SELLER  
**HEATED VEST**

**WARMTH WITH THE TOUCH OF A BUTTON** S-3XL

- Perfect for any outdoor activity
- Down-proof machine washable material with 160g of insulation for warmth with or without the heater turned on
- Powered by a small rechargeable battery (included); Battery not machine washable, remove prior to washing
- Easily adjust between 4 heat settings for changing weather conditions with built-in buttons

**MEN'S** 2833022 | **WOMEN'S** 2833036



\* TOP SELLER  
**HEATED BASE LAYER**

**ADJUSTABLE HEAT CLOSE TO YOUR BODY, MAXIMUM COMFORT IN CHANGING CONDITIONS** S-3XL

- Intended for use as a base layer
- Features lightweight, moisture-wicking fabric to give you the most comfortable layering to wear on all of your cold weather adventures, on or off the trail
- Includes multiple heat panels for evenly distributed heat for maximum warmth and comfort
- Powered by a small rechargeable battery (included); Battery not machine washable, remove prior to washing
- Easily adjust between 4 heat settings for changing weather conditions with built-in buttons

**WARMTH**  
ADJUST WARMTH LEVEL 1 TO 4 WITH THE TOUCH OF A BUTTON

**MEN'S**  
Top | 2833031  
Bottom | 2833032

**WOMEN'S**  
Top | 2833033  
Bottom | 2833034



\* TOP SELLER  
**HEATED GLOVE LINER**

**WARMTH WITH THE TOUCH OF A BUTTON** S-3XL

- Keeps your hands warm on those frosty days
- Designed to fit under all Polaris riding gloves for an extra layer of warmth to keep you out riding longer
- Easily adjust your heat level by pressing a button on the bottom part of the glove

**UNISEX** 2833044

## HEATED APPAREL REPLACEMENT BATTERY PACK

- Compatible with Polaris Men's & Women's Heated Base Layer Tops, Bottoms & Heated Vests
- Includes: 7.4V Lithium-Ion Battery with two 7.8V chargers (110V wall and 12V port)



2864582

## HEATED GLOVE LINER REPLACEMENT BATTERY PACK

- Compatible with Polaris Heated Glove Liners
- Includes: two 7.4V Lithium-Ion Batteries, one 100-240V charger



2864583



# WOMEN'S RIDING GEAR

Our innovative designs and advanced technical materials keep you warm, dry, and happy – head to toe – on every ride. TECH54 jackets, bibs, and monosuits provide ultimate protection and comfort for every type of rider. And our helmets offer styles, designs, and features just right for the way you ride.

# LAYERING

Anyone can layer up. But the key to staying warm and comfortable is picking the right layers for the conditions. Start with our moisture-wicking base layers to help maintain proper body temperature, then add a middle insulating or heated layer depending on the conditions.



# LIFESTYLE

Polaris hats, tees and jackets show others how you choose to live your life. This is well-crafted clothing that's purpose-built to keep you comfortable outdoors—right where you want to be.





**TECH54**



BLACK  
2865326



GRAY  
2865327



CABERNET  
2865328



BLACK  
2865329

20K/20K

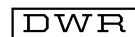

# NEW TETON

## JACKET

ADVANCED UNINSULATED JACKET WITH PREMIUM NEW FEATURES OFFERING MAXIMUM WATERPROOFNESS AND BREATHABILITY

S-3XL

- Three-layer stretch woven fabric for ultimate freedom of movement
- Features TECH54 Pro bonded internal laminate with 20k/20k properties
- Outer shell is treated with PFC-free DWR coating to shed snow and water
- Four external pockets (two hand, one chest and one sleeve pocket) plus an internal goggle or glove storage pocket
- Flow through ventilation with front and back vents to keep you cool
- Internal hand gaiters, integrated snow skirt and an adjustable, removable hood keeps snow out and allows for maximum versatility
- Highly visible in low light conditions with 3M® Scotchlite® Reflective Material

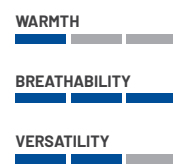

UNINSULATED

## BIB

ADVANCED UNINSULATED BIB WITH PREMIUM NEW FEATURES OFFERING MAXIMUM WATERPROOFNESS AND BREATHABILITY

S-3XL

- Three-layer stretch woven fabric for ultimate freedom of movement
- 600 denier reinforcements at knees, scuff guards and hems along with built-in kneepads for ultimate protection
- Features TECH54 Pro bonded internal laminate with 20k/20k properties
- Outer shell is treated with PFC-free DWR coating to shed snow and water
- One chest pocket and two thigh pockets (one with beacon tether)
- Articulated knees, waist adjustment with pull tabs and stretch panels at side for premium comfort
- Highly visible in low light conditions with 3M® Scotchlite® Reflective Material

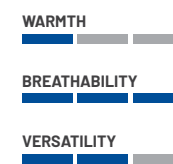

UNINSULATED



**TECH54**



BLACK  
2865330



OLIVE/BLACK  
2865331



DARK TEAL/LIME  
2865332



CABERNET/GRAY  
2865333



BLACK  
2864512

10K/10K



# NEW SWITCHBACK 2.0

## JACKET

TRUE THREE-IN-ONE VERSATILITY WITH A DURABLE SHELL AND A NEW WEARABLE, REMOVABLE LINER

S-3XL

- Durable 300 denier polyester shell is tear and snag-resistant and treated with superior PFC-free DWR to shed snow and water from the outer shell
- Features TECH54 bonded internal laminate with 10k/10k properties
- Removable and wearable puffer liner with zonal 140g insulation in body and 100g in arms
- Shock-cord adjustable bottom hem to keep snow out
- Removable/adjustable hood
- Three external zippered pockets (two hand, one chest)
- Zippered underarm vents for increased versatility and comfort
- Highly visible in low light conditions with 3M® Scotchlite® Reflective Material

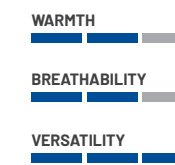

INSULATED

# SWITCHBACK

## BIB

PREMIUM BIB FEATURES ZONAL INSULATION AND BREATHABLE WATERPROOFNESS

S-3XL

- Durable 300 denier poly shell is tear- and snag resistant and treated with superior DWR to shed snow and water from the outer shell
- Features TECH54 bonded internal laminate with 10k/10k properties
- Insulated with 120g insulation in front and 80g in back
- Two thigh vents
- Storm cuffs with boot lace retention snaps
- Highly visible in low light conditions with 3M® Scotchlite® Reflective Material

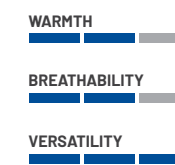



TECH54



**NEW**  
RETRO  
2865335

PURPLE  
2864513

TEAL/LAGOON  
2864514

BLUE  
2833014

BLACK/WHITE  
2862441

5K/5K

DWR

3M Thinsulate INSULATION

3M Scotchlite Reflective Material

YKK ZIPPERS

# NORTHSTAR 2.0

## JACKET

INSULATED AND DURABLE JACKET DELIVERS GREAT WARMTH

S-3XL

- Durable 300 denier poly shell is tear- and snag-resistant and treated with superior DWR to shed snow and water from the outer shell
- Features TECH54 bonded internal laminate with 5k/5k properties

- Insulated with 180g insulation in body and 100g in arms
- Shock-cord adjustable bottom hem and wrist gaiters keep the snow out
- Highly visible in low light conditions with 3M Scotchlite Reflective Material

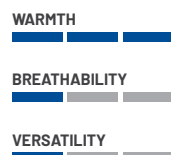

GRAY  
2864515

BLACK  
2862445  
S-3XL | XS-2XLS  
AVAILABLE IN SHORT

## BIB

INSULATED AND DURABLE BIB DESIGN PROVIDES ALL-DAY WARMTH WITH ZONAL INSULATION

S-3XL  
UNLESS NOTED

- Durable 300 denier poly shell is tear- and snag-resistant and treated with superior DWR to shed snow and water from the outer shell
- Features TECH54 bonded internal laminate with 5k/5k properties
- Insulated with 180g insulation in upper front of legs and lower back and 100g on upper backside
- Storm cuffs with boot-lace retention snaps
- Highly visible in low light conditions with 3M Scotchlite Reflective Material

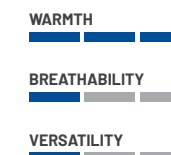

## WOMEN'S LAYERING

### BASE & MID-LAYERS

Quick-drying and quick-wicking. Rests against your skin to regulate your overall body temperature by wicking away moisture. Insulating layers for the right level of warmth for your riding conditions.



**BLACK**  
2865347

**DARK ROSE**  
2865348

**TEAL**  
2865349

#### **NEW** ROSEAU QUILTED VEST

VERSATILE LAYERING WITH CLASSIC PUFFER STYLING

S-3XL

- Durable polyester windbreak outer fabric helps protect from the elements
- 140g 3M® Thinsulate® Insulation keeps you warm in cold weather
- Classic color-block design and zippered hand pockets



**PURPLE**  
2864527

**TEAL/LAGOON**  
2864528

**BLACK/GRAY**  
2861447

#### TECH QUARTER-ZIP

FLEECE LINED MID-LAYER FOR ESSENTIAL WARMTH WHILE RIDING WITH THE STYLE AND COMFORT TO WEAR ANYWHERE

S-3XL

- Fleece-lining keeps you cozy and warm
- Move freely with four-way stretch material
- Moisture-wicking fabric keeps you warm and dry
- Contoured, slim fit



**TOP**  
2861455

**BOTTOM**  
2861456

#### MIDWEIGHT BASE LAYER

LIGHTWEIGHT, COMFORTABLE, MOISTURE-WICKING BASE LAYER

S-3XL

- Comfortable stretch fabric to allow for maximum movement
- 92% polyester, 8% spandex
- 220g fleece lined brushed fabric provides comfort and warmth



**GRAY**  
2862520

**BLACK**  
2862529

#### ADAPT QUARTER-ZIP **★ TOP SELLER**

EXTRA LIGHT MID-LAYER WITH A COMFORTABLE FIT

S-3XL

- Versatile use both on and off the trail
- A blend of polyester, cotton and rayon give this shirt a comfortable feel



**BLACK**  
2865371

**TEAL**  
2865372

#### **NEW** RANGE FULL-ZIP MID-LAYER

WARM AND BREATHABLE MID-LAYER, PERFECT FOR RIDING

S-3XL

- 330g, 100% polyester sweater-knit fleece with brushed fleece interior provides great warmth
- Cover-stitched seams for added durability
- Zippered side hand pockets for secure storage



**BLACK**  
2865368

**SAND**  
2865369

**CABERNET**  
2865370

#### **NEW** TRAVELER HALF-ZIP MID-LAYER

EXTREMELY WARM AND VERSATILE MID-LAYER CAN BE WORN ALONE OR AS AN EXTRA LAYER

S-3XL

- 330g, 100% polyester anti-pilling sherpa fleece for added warmth
- Zippered chest & hand pockets for secure storage



**GRAY**  
2865366

**DARK ROSE**  
2865367

#### **NEW** SWITCHBACK 2.0 MID-LAYER

BATTLE THE COLD WITHOUT THE BULK AND SLIDE YOUR JACKET ON EASILY

S-3XL

- 260g technical-face fleece made of a polyester/spandex blend enhances fit without restricting movement
- Zippered hand pockets for secure storage



**BLACK**  
2865501

#### **NEW** KNIT JOGGER

WARM & COMFORTABLE, PERFECT FOR RELAXING AFTER A DAY OF RIDING

S-3XL

- 270g fleece with moisture-management and anti-pilling
- Two zippered pockets - one back and one side
- Athletic fit





BLACK  
2865343

BLUE  
2865344

**NEW**  
SOFTSHELL JACKET 2.0

VERSATILE LIGHTWEIGHT JACKET THAT'S PERFECT FOR EVERYDAY WEAR

S-3XL

- Superior PFC-free DWR coating prevents precipitation from saturating the jackets exterior
- Lined with soft 125g fleece for warmth
- Shock-cord adjustable hood and bottom hem
- Two zippered hand pockets and one zippered chest pocket



BLACK  
2865345

TAN  
2865346

**NEW**  
RANGE WORK JACKET

RUGGED AND WARM JACKET THAT'S TOUGH FOR WORK AND COMFORTABLE FOR PLAY

S-3XL

- Durable stretch canvas with PFC-free DWR coating prevents precipitation from saturation outer shell
- 60g 3M® Thinsulate® Insulation provides warmth without added bulk
- Front cargo pockets along with two side-zippered hand pockets and zippered chest pocket for maximum storage



**NEW**  
MOUNTAIN GRADE HOODIE

S-3XL  
Black | 2865486  
Light Blue | 2865487



STACKED NEON V-NECK HOODIE

S-2XL  
**NEW** Black | 2865485  
Misty Blue | 2864670



UPF POLARIS HOODIE TEE **TOP SELLER**

S-3XL  
**NEW** Navy | 2865494  
Pink | 2833102  
Teal | 2833103



ROSEAU V-NECK SWEATER

FEEL GOOD WHILE LOOKING GOOD OFF THE TRAILS

S-3XL

- This pullover sweater features a V-Neck for versatility and comfort
- A soft cotton and polyester blend makes this sweater comfortable to wear



BLACK  
2862528



**NEW**  
SCENIC CREWNECK SWEATSHIRT

XS-2XL  
Charcoal | 2865482  
Blush | 2865483  
Ivory | 2865484



**NEW**  
TECH FULL-ZIP HOODIE

S-3XL  
Black | 2865509  
Teal | 2865510



**NEW**  
ODYSSEY HOODIE

S-3XL  
Dark Blue | 2865398  
Dark Rose | 2865399  
Gray | 2865397



BLACK  
2865340

DARK ROSE  
2865341

BLUE  
2865342

**NEW**  
ROSEAU PACKABLE PUFFER JACKET

PACKABLE JACKET OFFERS LIGHTWEIGHT PROTECTION AND INCREDIBLE WARMTH

S-3XL

- 140g 3M® Thinsulate® Insulation in body and arms, 100g insulation in hood
- Front zippered hand pockets
- Packs into left hand pocket for easy travel
- Classic color-block design



GRAY  
2865500

**NEW**  
LOOSE HIGH NECK HOODIE

COMFORTABLE AND LIGHTWEIGHT HOODIE IS PERFECT AS A LAYER OR RELAXING AFTER A DAY OF RIDING

S-3XL

- Adjustable hood with higher neck for added warmth
- Oversize front kangaroo pocket
- Soft and cozy polyester/spandex fleece for lightweight warmth



ICON HOODIE

S-3XL  
**NEW** Black | 2865481  
Blue | 2864589  
Gray | 2833099  
White | 2862512



STAPLE HOODIE **TOP SELLER**

S-3XL  
Blue | 2864607  
Deep Lagoon | 2864608  
Gray | 2833099  
Black | 2833095



**NEW**  
WOMEN'S PURSUIT HOODIE

S-3XL  
Camo | 2865488

PLAID FLANNEL SHIRT

COMFORTABLE YET DURABLE WITH A CLASSIC FIT, PERFECT FOR ANY OCCASION

S-3XL



**NEW**  
CABERNET/FUCHSIA  
2865496

BLUE  
2864673

TEAL  
2864674

- Exclusive plaid design
- 100% cotton brushed flannel shirt
- Two pocket-shirt silhouette



**NEW**  
EXPLORE OUTDOORS TEE  
S-3XL  
Red Heather | 2865470  
Navy Heather | 2865471



ADVENTURE TEE **TOP SELLER**  
S-3XL  
Heather Gray | 2864604  
Blue | 2864603  
Teal | 2862629



**NEW**  
OUTSIDE ADVENTURE TEE  
S-3XL  
Red | 2865474  
Green | 2865475  
Purple | 2865477



**NEW**  
PERFORMANCE LONG SLEEVE  
S-3XL  
Dark Rose | 2865478  
Dark Blue | 2865479  
Gray | 2865480



**NEW**  
LIFE OUTSIDE LONG SLEEVE  
S-3XL  
Red | 2865472  
Blue | 2865473



SHADOW SCRIPT LONG SLEEVE TEE **TOP SELLER**  
S-3XL  
Heather Gray | 2864622  
Blush | 2864623



HERITAGE TEE  
S-3XL  
Navy | 2864614  
Blue | 2864615



VENTURE TEE  
S-3XL  
Heather Gray | 2864625  
Turquoise | 2864626



THINK OUTSIDE TEE **TOP SELLER**  
S-3XL  
**NEW** Charcoal Heather | 2865466  
Olive | 2864598  
Purple | 2864597



ADVENTURE LONG SLEEVE  
S-3XL  
White | 2864611  
Gray | 2833107  
Navy | 2833108



**NEW**  
SILVER ICON TEE  
S-3XL  
Dark Teal Heather | 2865468  
Black | 2864627  
Purple | 2864628



**NEW**  
EAT. SLEEP. BRAP. TEE **TOP SELLER**  
S-3XL  
Teal Heather | 2865489  
Black | 2864688  
Pink | 2864689



**NEW**  
STACKED SANS TEE  
S-3XL  
White | 2865467  
Navy | 2864621



FLAG TEE **TOP SELLER**  
S-3XL  
Gray | 2833163  
White | 2833162



CORE TANK  
S-3XL  
Black | 2833161  
Gray | 2833160



FOR THE NEXT GENERATION OF  
**OUTDOOR ENTHUSIASTS**

YOUTH RIDING GEAR



RADIANT GREEN  
2833046

PURPLE  
2864516

BLACK  
2833045

RED  
2833048



**TECH54**

5K/5K



3M Thinsulate INSULATION

3M Scotchlite Reflective Material

YKK ZIPPERS

BLACK  
2833049



**SWITCHBACK**

JACKET

S-XL

- Durable 300 denier poly shell is tear- and snag-resistant and treated with superior DWR to shed snow and water from the outer shell
- Features TECH54 bonded internal laminate with 5k/5k properties
- 150g insulation in body and 100g in arms

- Shock-cord adjustable bottom hem keeps snow out
- Three external pockets (two hand, one chest)
- Highly visible in low light conditions with 3M® Scotchlite® Reflective Material

WARMTH

BREATHABILITY

VERSATILITY

INSULATED

BIB

S-XL

- Durable 300 denier poly shell is tear- and snag-resistant and treated with superior DWR to shed snow and water from the outer shell
- Features TECH54 bonded internal laminate with 5k/5k properties
- Insulated with 150g insulation in front and 100g in back

- Grow with me extension feature adjusts as your child grows taller
- Two external hand pockets
- Highly visible in low light conditions with 3M® Scotchlite® Reflective Material

WARMTH

BREATHABILITY

VERSATILITY

INSULATED

**NORTHSTAR**

GLOVE

S-XL

- Mapped insulation with 200g on back of hand and 100g on palm
- Goggle squeegee on index finger and nose wipe on the back of thumb
- Gauntlet shock-cord closure to keep snow out



BLACK  
2861463

APPAREL

MEN'S APPAREL

UNIRL x POLARIS

POLARIS HEATED APPAREL

WOMEN'S APPAREL

YOUTH APPAREL

HELMETS & GOGGLES

RIDER SAFETY

HATS & GLOVES

BOOTS, BALACLAVAS, & LUGGAGE

HOME & COLLECTIBLES



## YOUTH HELMETS & GOGGLES



**BLACK**  
2865418



**TEAL/LIME**  
2865420

### **NEW** YOUTH TACTICAL 3.0 HELMET

EMPOWER THE NEXT GENERATION OF RIDERS WITH CUTTING EDGE TECHNOLOGY

S-L

#### SHELL

- Poly and ABS Polymer construction ensures both strength and a lightweight feel for maximum protection

#### WEIGHT

- Starting at 1,300g

#### FEATURES

- Venturi Vent system generates negative pressure at velocity and pulls moist air from the breath box
- Cardo® UCS Compatibility - integration and easy assembly of Cardo® UCS modules (sold separately)
- Plush liner design
- Magnetic Fidlock® chin-strap technology to enable faster securing and removing of the helmet
- DOT-and ECE 22.06-approved



### BLAZE 2.0 HELMET

LIGHTWEIGHT SHELL COMBINED WITH FULL-FACE PROTECTION

S-XL

#### SHELL

- Injection-molded plastic

#### FEATURES

- Full face protection
- Provides great comfort and warmth
- Stylish, modern design
- Easy to operate flip shield
- Dual pane technology and anti-fog and anti-scratch coating for clear vision
- Perfectly placed intake and exhaust helps keep things cool under the lid
- Included breath guard with chin curtain shields out drafts and snow swirl
- DOT-approved



**BLACK**  
2833149



### YOUTH RIPPER GOGGLE

FEATURING EXCELLENT VISIBILITY, ANTI-FOG PERFORMANCE AND SCRATCH RESISTANT DURABILITY

**CRUISER BLACK**  
2864549



CLEAR

**NEW** **TEAL/LIME**  
2865429



SMOKE

## YOUTH LIFESTYLE



**NEW**  
YOUTH EXPLORE OUTDOORS  
LONG SLEEVE TEE  
S-XL  
Navy | 2865504



YOUTH PEAK GRAPHIC  
LONG SLEEVE TEE  
S-XL  
Heather Gray | 2864692



**NEW**  
YOUTH THINK OUTSIDE HOODIE  
S-XL  
Black | 2865505  
Cabernet | 2865506



YOUTH STAPLE HOODIE  
S-XL  
**NEW** Blue | 2865491  
Black | 2864609  
Gray | S-XL | 2864610



**NEW**  
YOUTH TECH FULL-ZIP HOODIE  
S-XL  
Black | 2865511  
Dark Teal | 2865512



YOUTH EAT. SLEEP. BRAP. TEE  
S-XL  
Black | 2864690  
Red | 2864691



**NEW**  
YOUTH OUTSIDE ADVENTURE TEE  
S-XL  
Red | 2865502  
Green | 2865503



YOUTH HERITAGE TEE  
S-XL  
Navy | 2864629



YOUTH ICON TEE  
S-XL  
**NEW** Navy | 2865490  
Blue | 2864599  
Black | 2862552

## YOUTH HATS



YOUTH JOURNEY CAP  
S-XL  
Black | 2833140  
Navy | 2833141



**NEW**  
YOUTH HERITAGE  
SNAPBACK CAP  
S-XL  
Navy | 2865524  
Gray | 2865523



**NEW**  
YOUTH DOUBLE  
POM BEANIE  
Gray | 2865533  
Blue | 2864713



**NEW**  
YOUTH  
SNOWFLAKE BEANIE  
Light Purple/Gray | 2865534



YOUTH SWITCHBACK  
BEANIE  
Purple | 2864712  
Blue | 2862550  
Gray | 2862551

APPAREL

MEN'S APPAREL

UNIR® x POLARIS

POLARIS  
HEATED APPAREL

WOMEN'S APPAREL

YOUTH APPAREL

HELMETS  
& GOGGLES

RIDER SAFETY

HATS & GLOVES

BOOTS, BALACLAVAS,  
& LUGGAGE

HOME  
& COLLECTIBLES

# FUELING YOUR PASSION

Relentlessly driven by our passion for riding and the outdoors, 509 is the fuel that enables you to live your passion for adventure through innovative products and inspiring storytelling.

The lineup of 509 helmets for Polaris features innovative technology, next-level design, and the versatility to ride confidently in any terrain. Whether you're ascending deep mountain powder or enjoying a perfectly groomed trail, 509 for Polaris has a helmet to fit your riding passion.



## IGNITE

### IGNITE DUAL-PANE CLIMATE CONTROL

Ride confidently knowing your vision will be fog-free and crystal clear as you maneuver through the trails.

SCAN THE QR CODE TO LEARN MORE ABOUT HOW TO POWER YOUR HEATED SHIELD.



The lineup of 509 helmets for Polaris features Fidlock® technology, an easy-on and easy-off magnetic closure device that delivers a quick, secure closure every time.



- EASY ONE-HAND OPENING
- EVEN WITH GLOVES
- DOT- AND ECE-APPROVED

## THE RIGHT HELMET FOR YOUR RIDE

Find the helmet that fits your riding style with the best combination of features at a price that's right for you.

### MODULAR

- Versatile flip-open front chin
- Electric shield optional
- Wide field of view for peripheral sightlines

### FULL FACE

- Full Face Protection
- Electric shield optional
- Easy to operate flip shield

### MOTO

- Full-helmet ventilation
- Removable breath box
- Enables preferred goggle & lens selection

### ULTIMATE



#### 509 DELTA R4

Ultimate all-in-one modular design with exceptional vision, comfort and convenience.



#### 509 DELTA V COMMANDER

No longer a helmet, it's a cockpit.

#### 509 DELTA V CARBON IGNITE

Built for long rides, at speed, in cold temperatures.



#### 509 ALTITUDE 2.0

Lightweight design, performance-infused style, and GOPRO® mounting capability

### PREMIUM



#### MODULAR 2.0

Sophisticated style, electric shield equipped and perfect for a long day riding.



#### 509 DELTA R3L

Unlimited versatility in dual-sport, full-face or open configurations with premium protection.



#### 509 TACTICAL 3.0 MTN

Combines style with versatility for ultimate comfort and control.

### BASE



#### MODULAR 1.0

Simple in design, big on features and functionality.



#### BLAZE

Lightweight shell combined with full-face protection.



#### TENACITY 4.0

Modern style, premium protection, incredible value.



### MAKE ANY HELMET A SMART HELMET WITH THE CARDO PACKTALK EDGE

Connect with other riders with this Cardo Packtalk Edge Bluetooth® wireless mic, available as a single or duo pack. Attach it to the side of your helmet and put the speakers in your helmet to easily communicate with other riders on the go.



SCAN TO LEARN MORE



CARBON FIBER  
BLACK  
2833158



WHITE  
2833150



BLACK  
2833151

# 509 DELTA V COMMANDER



NO LONGER A HELMET, IT'S A COCKPIT

S-2XL

**SHELL**

- Carbon Fiber
- Lightweight polycarbonate

**WEIGHT**

- Up to 1,832g

**FEATURES**

- The Delta V Commander features an integrated communication system, infinity style sealed IGNITE heated shield, and ergonomic design
- Features in-helmet JBL® speakers for audio and an integrated microphone to connect up to 14 users in a group with the best sound and noise cancellation for all your rides
- Venturi Vent Ducting, an integrated spoiler, and low-profile antennae keeps this helmet sleek, quiet, and fog-free all day on the trails
- 12-volt power input on left side powers shield, comms, and chase light with controls for bright, normal, and off positions
- Battery power for up to 10 hours of riding
- Connect via Bluetooth® to your music, phone, maps, and sled
- DOT/ECE 22.06 dual certified helmet shell and luxurious liner
- Fidlock® chinstrap for easy on and off



CARBON FIBER  
WHITE  
2833152



CARBON FIBER  
BLACK  
2833153

# 509 DELTA V CARBON IGNITE



BUILT SPECIFICALLY FOR SUSTAINED LONG RIDES, AT SPEED, IN COLD TEMPERATURES

S-2XL

**SHELL**

- Carbon fiber

**WEIGHT**

- Up to 1,807g

**FEATURES**

- Hand-laid carbon fiber construction for lightweight and durable performance
- Powered helmet – 12 volt power input on left side to power shield
- IGNITE heated shield is powered by your snowmobile's battery, and comes with all required connection cables
- Compatible with 509 12 volt power pack system, for 10 hours of riding
- Innovative Venturi Vent pulls moist air from helmet without cold wind coming into helmet
- Premium liner for a comfortable and quiet fit
- Ignite dual pane heated shield for fog-free performance
- DOT/ECE 22.06 dual certified helmet shell
- Fidlock® chinstrap for easy on and off



**NEW**  
OLIVE/BLACK  
2865402



**NEW**  
CABERNET/GRAY  
2865403

# 509 DELTA R3L

**IGNITE FIDLOCK**

UNLIMITED VERSATILITY IN DUAL-SPORT, FULL-FACE OR OPEN CONFIGURATIONS WITH PREMIUM PROTECTION

XS-2XL

**SHELL**

- Lightweight polycarbonate

**WEIGHT**

- 1,680g

**FEATURES**

- Dual-sport, full-face or open face configuration options
- Dual-pane anti-scratch, anti-fog coated ITO electric clear shield
- Comes standard with the Fidlock® easy-open magnetic strap buckle
- Drop-down internal sun shield in amber
- Push-button removable shield
- Removable cold-weather chin curtain
- Removable/washable liner and cheek pads
- DOT-approved



ZENITH BLUE  
2864540



RETRO  
2862463



BLACK  
2861467



**NEW**  
DARK BLUE  
2865406



BLACK  
2861464



RED  
2864539

# 509 DELTA R4

**IGNITE FIDLOCK**

ULTIMATE ALL-IN-ONE MODULAR DESIGN WITH EXCEPTIONAL VISION, COMFORT AND CONVENIENCE

XS-2XL

**SHELL**

- Lightweight polycarbonate

**WEIGHT**

- 1,680g

**FEATURES**

- Wide field of view for extended peripheral sightlines
- Heated dual-pane shield for ice-and fog-free vision
- IGNITE heated shield is powered by your snowmobile's battery, and comes with all required connection cables
- Easy one-handed, glove-friendly latch activation
- Magnetic Fidlock® chin strap secures quickly
- Adjustable flow-through venting for comfort
- DOT-approved



TEAL/LIME  
2865411



BLUE  
S-4XL | 2865412

**NEW**  
**509 TACTICAL 3.0 MTN**



EXPERIENCE TOP-TIER PROTECTION, COMFORT, AND CONNECTIVITY IN THE MOUNTAINS

XS-4XL  
UNLESS NOTED

**SHELL**

- Poly and ABS Polymer Construction - ensures both strength and a lightweight feel for maximum protection

**WEIGHT**

- Starting at 1,300g

**FEATURES**

- Venturi Vent system generates negative pressure at velocity and pulls moist air from the breath box
- Cardo® UCS Compatibility - integration and easy assembly of Cardo® UCS modules (sold separately)
- Magnetic Fidlock® chin-strap technology

- Plush liner design
- Compatible with VEES Protection System (sold separately) for cold days
- DOT- and ECE 22.06-approved



RETRO  
S-4XL | 2865409



BLACK  
2865408



VEES LINER  
2865514



**NEW**  
GRAY/MAROON  
2865400



CARBON FIBER  
BLACK/LIME  
2861473



CARBON FIBER  
WHITE  
2864538

**509 ALTITUDE 2.0**



LIGHTWEIGHT DESIGN, PERFORMANCE-INFUSED STYLE, AND GOPRO® MOUNTING CAPABILITY

XS-4XL

**SHELL**

- Thermoplastic poly alloy outer shell

**WEIGHT**

- Composite as low as 1,200g
- Carbon fiber as low as 1,150g

**FEATURES**

- Strong, lightweight construction of carbon fiber or composite
- Superior fit for all-day comfort
- Integrated Pro Series breath box provides excellent ventilation and air flow

- One-piece eyepoint creates draft-free seal with 509 goggles
- Magnetic Fidlock® chin-strap technology and integrated GOPRO® mount
- DOT-approved



BLACK  
2861469

LEARN MORE AT  
[POLARIS.COM/SNOWHELMETS](https://www.polaris.com/snowhelmets)



**GLOSS BLACK/WHITE/ORANGE SMOKE SUN SHIELD**  
2864556



**GLOSS BLACK/GRAY/LIME SMOKE SUN SHIELD**  
2864558



**GLOSS WHITE/PURPLE SMOKE SUN SHIELD**  
2864557

**NEW MATTE DARK BLUE SMOKE SUN SHIELD**  
2865433



**GLOSS RETRO AMBER SUN SHIELD**  
2862475



**MATTE BLACK AMBER SUN SHIELD**  
XS-5XL | 2868552

# MODULAR 2.0

A MODULAR HELMET FOR THE MODERN RIDER – SOPHISTICATED STYLE, ELECTRIC SHIELD EQUIPPED AND PERFECT FOR A LONG DAY ON THE TRAIL

XS-4XL  
UNLESS NOTED

**SHELL**

- Impact-resistant injection-molded plastic shell

**WEIGHT**

- 1,850g

**FEATURES**

- Rubber silicone breath box for a contoured fit
- Added chin and neck sealing for comfort and noise protection
- Breath box attachment system for easy conversion
- Push-button air vent for easy use with gloves on
- Steel hook and catch for closing mechanism
- Articulated chin bar with push-button action
- Lever-activated sun shield that's scratch- and fog-resistant
- ProClip quick-release chin strap
- Interior space for communication speakers
- Washable liner and cheek pads
- DOT-approved

**MODULAR 1.0/1.5/2.0 REPLACEMENT PARTS**

- Electric Dbl Lens Led Tranz/Rr | 2861235
- Electric Cord, D/L Tranz | 2861236
- Breath Deflector | 2862136
- Breath Guard | 2862137
- Ratchet Kit/Side Plate | 2862140

**ADDITIONAL REPLACEMENT DROP-DOWN VISOR FOR LOW LIGHT AVAILABLE FOR PURCHASE**

- Mod 2.0 Smoke Drop Down Visor | 2861551
- Amber | 2861563



**MATTE BLACK NON-ELECTRIC SHIELD**  
2868557



**MATTE BLACK ELECTRIC SHIELD**  
S-5XL | 2869689

# MODULAR 1.0

SIMPLE IN DESIGN, BIG ON FEATURES AND FUNCTIONALITY

XS-5XL  
UNLESS NOTED

**SHELL**

- Injection-molded plastic

**WEIGHT**

- 1,850g

**FEATURES**

- Features neoprene breath box
- Articulated chin bar with push-button action
- Durable plastic hook and catch for closing mechanism
- Two-finger, easy-open mechanism
- Added visual comfort with lever-activated, scratch-resistant sunshield
- ProClip quick-release chin strap
- Interior space for communication speakers
- Washable liner and cheek pads
- DOT-approved

# BLAZE 2.0

LIGHTWEIGHT SHELL COMBINED WITH FULL-FACE PROTECTION

XS-2XL

**SHELL**

- Injection-molded plastic

**WEIGHT**

- 1,450g

**FEATURES**

- Full face protection
- Provides great comfort and warmth
- Stylish, modern design
- Easy to operate flip shield
- Dual pane technology and anti-fog and anti-scratch coating for clear vision
- Perfectly placed intake and exhaust help keep things cool under the lid
- Included breath guard with chin curtain shields out drafts and snow swirl
- DOT-approved



**BLACK**  
2833146



**NEW MAROON/FUCHSIA**  
2865435



**NEW GRAY/BLUE**  
2865434



**ORANGE/TAN**  
2864559



**BLACK**  
2864859



**GRAY/LIME**  
2864560



**BLACK/GRAY**  
2861558



**BLUE**  
2833143

# TENACITY 4.0

COMBINATION OF MODERN STYLE AND PREMIUM PROTECTION WITH INCREDIBLE VALUE

XS-2XL

**SHELL**

- Shock-resistant, injection-molded thermoplastic

**WEIGHT**

- 1,500g

**FEATURES**

- Through-flow, full-helmet ventilation
- ProClip quick release chin strap allows you to fasten the chin strap in seconds
- Removable breath box
- Toolless adjustable roost shield
- Removable, washable liner
- DOT/ECE 22.06 dual certified helmet shell

LEARN MORE AT  
[POLARIS.COM/SNOWHELMETS](http://POLARIS.COM/SNOWHELMETS)

## GOGGLES

### NEW MAROON/ORANGE

2865432



FIRE MIRROR LIGHT ROSE TINT

### ZENITH BLUE

2864547



SAPPHIRE MIRROR LIGHT BLUE HCS TINT

### ORANGE

2864548



YELLOW HCS TINT

### STEALTH

2833155



CLEAR SMOKE

### RETRO

2833156



CLEAR SMOKE

## CARRY MULTIPLE LENSES SO YOU CAN EASILY ADJUST FOR LIGHTING FROM DAWN TO DUSK

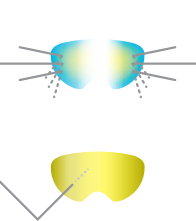

### MIRRORED

- Reduces glare by reflecting light
- Maintains visibility of LCD readouts
- Paired with lighter tints to offset darkening

### POLARIZED

- Substantially reduces glare & blinding
- Blocks horizontal light waves
- Decreases eyestrain



### BLUE

Reduces eyestrain



### YELLOW

Enhances flat-light terrain definition



### CLEAR

Increases contrast in cloudy conditions



### SMOKE

Cuts down brightness without color distortion



### ROSE

Delivers superior low-light visibility

# X7

## 509 SINISTER X7 SNOW GOGGLE

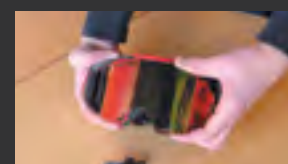

QUICK CHANGE 5MAG MAGNETIC LENS TECHNOLOGY

SWAP OUT LENSES WITH EASE

### SINISTER X7 LENSES

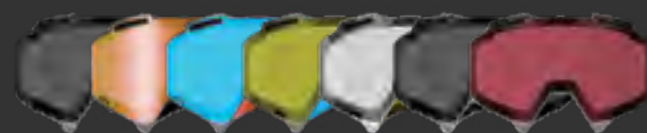

POLARIZED SMOKE TINT	2864555	CLEAR	2833173
FIRE ROSE	2833170	SMOKE	2833174
BLUE	2833171	ROSE	2833175
YELLOW	2833172		

## 509 FOR POLARIS

FEATURING EXCELLENT VISIBILITY, ANTI-FOG PERFORMANCE AND DURABILITY

- 5MAG lens retention system is a magnetic lens technology for quick and easy lens changing on the go
- Soft goggle frame for unparalleled comfort and fit
- Hard lens frame insures an optimal fit and a great seal
- Over the glasses compatible
- Shuttered venting in frame scoop air in or closes off flow
- Easily replace lens for varying conditions
- Improved tints, low light, and contrast improving technologies including polarized, HCS, and photochromatic also available

### NEW TEAL/LIME

2865425

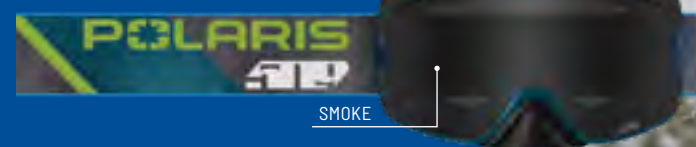

SMOKE

### NEW BLUE

2865426



CHROME MIRROR CLEAR TINT

### BLACK/WHITE

2864544

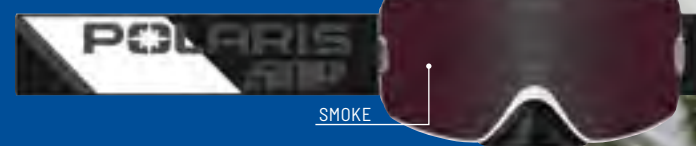

SMOKE

### RETRO

2862555



CLEAR

### PURPLE

2864543



RASPBERRY MIRROR SMOKE TINT

### BLACK/GRAY

2861476



SMOKE

# KINGPIN

## KINGPIN 509 SNOW GOGGLE

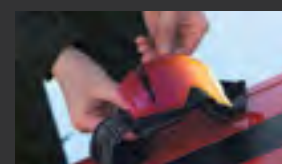

QUICK-CHANGE LENS TECHNOLOGY

SWAP OUT LENSES WITH EASE

### KINGPIN LENSES



CLEAR	2868547
YELLOW	2868548
CHROME	2868549
POLARIZED SMOKE	2868550

## 509 FOR POLARIS

PREMIUM MATERIALS IN AN AFFORDABLE PACKAGE

- Oversized spherical lens delivers optimal peripheral vision
- Maximum anti-fog and scratch-resistant
- Contoured frame and triple-layer foam seals out cold and snow
- Removable nose piece delivers versatile cold-weather protection
- Quick-change lens technology for fast lens-tint swaps

FIND THE PERFECT LENS FOR EVERY LIGHT CONDITION AT [POLARIS.COM/SNOWGOGGLES](http://POLARIS.COM/SNOWGOGGLES)

APPAREL

MEN'S APPAREL

UNIR® x POLARIS

POLARIS HEATED APPAREL

WOMEN'S APPAREL

YOUTH APPAREL

HELMETS & GOGGLES

RIDER SAFETY

HATS & GLOVES

BOOTS, BALACLAVAS, & LUGGAGE

HOME & COLLECTIBLES

141

# RIDE SAFELY TODAY SO YOU CAN RIDE SAFELY TOMORROW.



Polaris is proud to partner with PIEPS®, the world's foremost authority in snowmobile avalanche safety equipment. Designed with riders in mind, PIEPS® has over 45 years of experience in developing and testing the absolute best in avalanche airbag, beacon, probe and related safety technologies. Ride with confidence knowing you have state-of-the-art equipment and the skills to face a backcountry emergency.



## PIEPS® JETFORCE BT

ADVANCED LIGHTWEIGHT PERFORMANCE LOADED WITH TECHNOLOGY

Smartphone updates and Bluetooth® connectivity, automatic airbag deflation and modular booster system adapt to your riding needs.

- Digital, lithium-ion-powered turbine fan system allows for practice deployments at home
- Quickly and conveniently recharge with micro-USB
- Integrated self-diagnostic lights inform when pack is ready or requires charging
- Deployment handle can be located on the left or right for rider-preference control
- Available in 10L, 25L and 35L capacities for riding essentials
- Adjustable hip belt and leg loop ensure packs stay secure while riding

### JETFORCE BT EXCLUSIVE EXTRAS

- Automatic deflation sequence creates an air pocket under the snow
- Update software with Bluetooth® connectivity and PIEPS® App
- Customize pack's capacity with interchangeable booster in 10L, 25L or 35L, sold separately



Easy access safety pocket for shovel blade, handle and probe



	JETFORCE BT 10	JETFORCE BT 25	JETFORCE BT 35
<b>PACK CAPACITY</b>	10L	25L	35L
<b>WEIGHT</b>	6.3lbs / 2.84kg	6.6lbs / 2.98kg	6.7lbs / 3.04kg
<b>AIRBAG VOLUME</b>	170L	170L	170L
<b>BLACK</b>	2883672	2883673	2884311

INTERCHANGEABLE BOOSTER: CUSTOMIZE YOUR PACK CAPACITY AND COLOR



	JETFORCE BT 10	JETFORCE BT 25	JETFORCE BT 35
<b>CHILI RED</b>	2884313	2884316	2884319
<b>SKY BLUE</b>	2884314	2884317	2884320
<b>BLACK</b>	2884315	2884318	2884321





**PIEPS® JETFORCE SC** ★ TOP SELLER

**BEST-SELLING PERFORMANCE WITH SUPERCAPACITOR SYSTEM**

Featuring Alpride® E1 supercapacitor airbag technology. Cartridge-free system is compact, easy to use and charges in under 60 minutes—even while riding.

- Supercapacitor powered fan system allows for convenient practice deployments
- Quickly and conveniently recharge with micro-USB or AA batteries
- Self-diagnostic lights inform when pack is ready or requires charging
- Deployment handle can be located on the left or right for rider-preference control
- Easy-access safety pocket for shovel blade, handle and probe
- Convenient 20L internal compartment holds riding essentials
- Adjustable hip belt and leg loop ensure packs stay secure while riding



VOLUME	20L
WEIGHT	5.7lbs / 2.60kg
AIRBAG VOLUME	150L
BLACK	2883674

**PIEPS® POWDER BT**

High-performance circular receiving range, 300-hour battery life and PIEPS® App connectivity.

MAXIMUM RANGE	60m
SEARCH STRIP WIDTH	60m
WEIGHT	220g (including batteries)
BATTERY LIFETIME	Min. 300 h SEND-mode with Lithium batteries Min. 200 h SEND-mode with Alkaline batteries
POWER SUPPLY	3x Alkaline (AAA) / 3x Lithium (AAA)
DIMENSIONS (LxWxH)	118 x 76 x 29mm

2883676

**NEW**

**PIEPS® PRO IPS**

PIEPS® presents a new, groundbreaking avalanche transceiver with 80m search strip width and an especially stable transmission and search performance thanks to its INTERFERENCE PROTECTION SYSTEM (IPS) and DUAL ANTENNA SIGNAL PROCESSING (DASP) technology.

MAXIMUM RANGE	70m
SEARCH STRIP WIDTH	80m
WEIGHT	212g (including batteries)
BATTERY LIFETIME	Min. 600 h SEND-mode with Lithium batteries Min. 400 h SEND-mode with Alkaline batteries
POWER SUPPLY	3x Alkaline (AAA) / 3x Lithium (AAA)
DIMENSIONS (LxWxH)	120 x 75 x 24mm

2890090



**PIEPS® IPROBE BT**

Optical and acoustic signal indicates an electronic "hit" within a 1m diameter to eliminate near misses and false strikes when probing, saving valuable time during a rescue.

TUBES	6
TUBE DIAMETER	12.5mm
LENGTH	260cm
WEIGHT	430g

2884969

**PIEPS® SHOVEL T 825 PRO+ WITH SAW BLADE**

The PIEPS® SHOVEL T825 Pro+ with integrated snow saw and extra-large blade is perfect for snow layering analysis and bivouac building.

BLADE DIMENSIONS	30.5 x 24cm 4 x 4.5cm
TOTAL WEIGHT	825g
HANDLE LENGTH	80cm

2883680



**PIEPS® CARBON TOUR 260 PROBE**

Weight: 270g | 2884312



**PIEPS® ALUMINUM 260 PROBE**

Weight: 300g | 2883678



The Freestyle delivers versatile, reliable and comfortable upper body protection and outstanding value.

**TEKVEST® FREESTYLE XS-3XL**

- Adjustable strap system for a perfect fit
- Strong, protective, ultra-high molecular weight panels cover shoulders
- Front and rear mesh panels promote cooling airflow



BLACK  
2862577

FOR ADDITIONAL AVALANCHE SAFETY PRODUCT INFORMATION VISIT [POLARIS.COM/SNOWSAFETY](http://POLARIS.COM/SNOWSAFETY)



**HERITAGE LOGO SNAPBACK CAP**  
 Gray | 2865521  
 Navy | 2865522



**SHADOW LOGO CAP**  
 Black | 2865519  
 Olive | 2865520



**HALF DOME PATCH CAP**  
 Black | 2864576  
 Tan | 2864577



**JOURNEY CAP**  
 Light Blue | 2864570  
 Black | 2833136  
 Blue | 2833137



**STAPLE CAP** \*TOP SELLER  
 Maroon | 2865516  
 Cypress | 2864568  
 Black | 2833127  
 Navy | 2833128



**METAL BADGE PANEL CAP**  
 Dark Blue | 2865517  
 Sand | 2865518  
 Cypress | 2864574  
 Black | 2864575



**FAIR ISLE TASSEL BEANIE**  
 Black/White | 2864711



**LEATHER PATCH CAP**  
 Cypress | 2864569  
 Black | 2833129  
 Gray | 2833130



**HEX PATCH COOLING CAP**  
 Black | 2864571  
 Blue | 2864572  
 Gray | 2864573



**HIGHLAND CAP**  
 Red | 2864567  
 Navy | 2833126  
 Gray | 2833506



**FAIR ISLE POM BEANIE**  
 Maroon/Orange | 2865530  
 White | 2864701  
 Teal | 2864702



**SPACE DYE POM BEANIE**  
 Sand | 2865527  
 Blue | 2864703  
 Pink | 2864704



**CABLE KNIT REMOVABLE POM BEANIE**  
 Black | 2865528  
 Gray | 2865529



**ELLIPSE PATCH TRUCKER HAT**  
 Cypress | 2864562  
 Purple | 2864563  
 Gray | 2833498  
 Black | 2833500  
 Navy | 2833499  
 Orange | 2833124



**CORE CAP** \*TOP SELLER  
 Red | 2833123  
 Gray | 2833505  
 Navy | 2833494  
 Black | 2833495



**TONAL HAT**  
 Orange | 2864564  
 Black/Red | 2833497  
 Navy | 2833496



**PEAK JACQUARD BEANIE**  
 Blue | 2864698  
 Red | 2864699



**RETRO PATCH BEANIE**  
 Navy | 2864697



**MARLED CUFF BEANIE**  
 Pink | 2864707  
 Gray | 2864706



**SWITCHBACK BEANIE** \*TOP SELLER  
 Olive | 2864694  
 Blue | 2833115  
 Black | 2862532  
 Gray | 2862533



**RETRO CAP** \*TOP SELLER  
 Blue | 2864580  
 Navy | 2833503  
 Black | 2833125  
 Gray/Red | 2869542



**STEALTH CAMO CAP**  
 Camo | 2861527



**HUNTER ORANGE HAT**  
 Orange | S/M | 2860892  
 Orange | L/XL | 2862545



**SHIELD PATCH CAP**  
 Navy | 2864578  
 Red | 2864579



**STAPLE BEANIE** \*TOP SELLER  
 Radiant Green | 2833121  
 Purple | 2864693  
 Black | 2833116  
 Navy | 2833117



**LOOSE FIT BEANIE**  
 Cabernet | 2865531  
 Olive | 2864708  
 Fuchsia | 2864709  
 Black/White | 2864710



**CORE BEANIE** \*TOP SELLER  
 Red | 2864695  
 Olive | 2864696  
 Blue | 2833114  
 Black | 2862530  
 Orange | 2862595

# HEATED

## GLOVE LINER

S-3XL

- Keeps your hands warm on those frosty days
- Designed to fit under all Polaris riding gloves for an extra layer of warmth to keep you out riding longer
- Easily adjust your heat level by pressing a button on the bottom part of the glove

HEATING ELEMENT

UNISEX  
2833044



## HEATED GLOVE LINER REPLACEMENT BATTERY PACK

- Compatible with Polaris Heated Glove Liners
- Includes: (2) 7.4V Lithium-Ion Batteries, (1) 100-240V charger

2864583



NEW

# TETON

## GLOVE

S-3XL

- Articulated leather palm with pre-curved grip for excellent control and feel
- Adjustable wrist strap with EVA Pad Protection seals out snow
- 100g 3M® Thinsulate® Insulation at back of hand and thumb
- Left index finger goggle squeegee helps keep vision clear
- E-touch thumb and index finger are touchscreen compatible

INSULATION

PADDING

GRIP



MEN'S  
2865373



MEN'S  
2862480



# TITAN

## LEATHER GLOVE

S-3XL

- Durable glove with reinforced leather on palm for long-lasting wear and excellent control and feel
- 300g 3M® Thinsulate® Insulation on back of hand and 100g 3M® Thinsulate® Insulation on palm
- 3M® Scotchlite® Reflective Material for added safety in all weather conditions
- Built-in goggle wipe

INSULATION

PADDING

GRIP



MEN'S  
2861460



# SWITCHBACK

## GLOVE

S-3XL

- Reinforced leather palm for excellent control and feel
- Integrated goggle wipe effectively clears snow, moisture and ice
- Removable fleece liner and 150g of 3M® Thinsulate® add versatility and warmth
- Touch-screen compatible

INSULATION

PADDING

GRIP



# NORTHSTAR

## GLOVE

S-3XL

- Premium performance with rugged polyester and leather construction
- Reinforced leather palm provides excellent control and feel
- Men's zonal warmth of 250g of 3M® Thinsulate® on backside and 150g in palm
- Women's zonal warmth of 300g of 3M® Thinsulate® on backside and 150g in palm

INSULATION

PADDING

GRIP



WOMEN'S  
2861462



MEN'S  
2861461

NEW

# RANGE

## WORK GLOVE

S-3XL

- Lightweight & uninsulated, these rugged yet comfortable gloves are designed for work or the trail
- Faux leather palms grip even when wet
- Molded neoprene knuckles for added durability and protection
- Integrated terry goggle wipe at thumb and Smart touch material at index, middle finger and thumb

INSULATION

PADDING

GRIP



MEN'S  
2865392

## BOOTS & BALACLAVAS



ICE LOCK® SOLE TECHNOLOGY



800G OF 3M® THINSULATE® INSULATION

### BOA® LACING SYSTEM VS. LACES

Push to engage. Turn to tighten. Pull for quick release. The BOA® lacing system is easier to get on and off than traditional lace-up boots and gives a perfect fit with the turn of a knob. Even with gloves on.

**TECH54**

3M  
**Thinsulate**  
INSULATION

3M  
**Scotchlite™**  
Reflective Material

### SWITCHBACK 2.0 BOOT

#### PERFORMANCE, WARMTH AND COMFORT

- Waterproof and breathable TECH54 membrane keeps moisture out and allows perspiration to escape to keep your feet dry and comfortable
- 800g 3M® Thinsulate® Insulation helps provide warmth in cold weather
- Durable leather material
- BOA® lacing system
- Hypergrip outsole with Icelock provides better traction on wet and slippery surfaces

#### SIZES: 5-14

INSULATION

TRACTION

WEIGHT



BLACK  
2862481

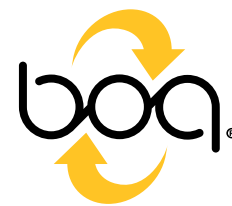

### MOUNTAIN BALACLAVA

- Laser-cut breath holes
- Windproof four-way stretch material blocks wind in key areas while providing extreme comfort

2861474



### TRAIL BALACLAVA

- Anti-fog neoprene nose guard
- Heavier windproof four-way stretch material blocks wind in key areas while providing extreme comfort

2861475

## LUGGAGE



**OGGIO®**

OGGIO

### 9800 RIG ROLLER

- SLED (Structural Load Equalizing Deck) system for increased durability and handling in the harshest of conditions
- Large main compartment with adjustable dividers and padded helmet chamber
- iFOM (integrated foam) construction throughout for added gear protection
- Heavy-duty oversized wheels with extra clearance
- Telescoping pull handle
- Dimensions: 32"H x 16.5"W x 15.25"D

2861483

OGGIO

### CARRY-ON BAG

- Custom in-line skate wheels and locking retractable handles provide optimum mobility
- 2-stage Pullman handle
- Internal compression straps
- Airline regulation carry-on size with 3" expansion zipper
- Dimensions: 22"H x 14"W x 10"D

2861486



OGGIO

### DUFFLE BAG

- Front zippered pocket
- Fabric-wrapped handle and padded shoulder strap
- Ventilated shoe compartment with grab handle
- Dimensions: 24"H x 12"W x 9"D

2861607



OGGIO

### EXPLORER BACKPACK

- Easy-to-reach essential gear compartments and pockets
- Sewn-in EVA molded compartment that protects your fragile and valuable items
- Luggage handle pass-through for easy transport and mobility
- Dimensions: 19.5"H x 14"W x 1.5"D

2861485



OGGIO

### SPOKE BAG

- Large main compartment with roll-out changing mat
- Lightweight for greater carrying capacity
- Two-stage trolley handle and reinforced replaceable wheel set
- Dimensions: 32"H x 16.5"W x 16"D

2861487

APPAREL

MEN'S APPAREL

UNRL® x POLARIS

POLARIS HEATED APPAREL

WOMEN'S APPAREL

YOUTH APPAREL

HELMETS & GOGGLES

RIDER SAFETY

HATS & GLOVES

BOOTS, BALACLAVAS, & LUGGAGE

HOME & COLLECTIBLES



**NEW**  
POLARIS RUMPL®  
BLANKET  
2864858



**NEW**  
POLARIS NEON CLOCK  
15" | 2865568



**NEW**  
PINT GLASSES  
(SET OF 2 W/ BOTTLE OPENER)  
2864720



POLARIS LOWBALL GLASSES  
W/ COASTERS (SET OF 2)  
2864721



PREMIUM KOOZIE  
\* TOP SELLER  
2860829



**NEW**  
ALUMINUM FLASK  
GIFT SET  
2864719



POLARIS KEY RACK  
12" x 8" | 2864718



LED SIGNS  
A. **NEW** Heritage LED Sign | 31.5" x 6.5" | 2865569  
B. Polaris Racing LED Sign | 31.5" x 9" | 2862737  
C. Polaris LED Sign | 31.5" x 6.5" | 2862736



ALUMINUM SIGN  
22" | 2860867



**NEW**  
RETRO CORRUGATED  
METAL SIGN  
32" x 28" | 2864717



POLARIS PVC COASTERS  
2864715



KICKBACK ROCKER  
\* TOP SELLER  
**NEW** Green | 2864816  
Blue | 2862626



FREESTYLE ROCKER  
\* TOP SELLER  
Black | 2862625



EASY CHAIR  
\* TOP SELLER  
Black | 2862627



WOOD SIGN  
24" x 10.5" | 2860866



POLARIS STEEL SIGN  
36" x 14" | 2860868



POLARIS PARKING SIGN  
2869934



POLARIS FLAG  
5' x 3' | 2869928



**NEW**  
PICO CHAIR  
\* TOP SELLER  
Black | 2864817



QUICK-E-SEAT  
Black | 2862624



FOLDABLE TABLE  
Black | 2861620



KEY CHAINS  
\* TOP SELLER  
Leather Loop | 2861615  
Black Leather | 2861616  
Polaris PVC Keychain | 2861614



POLARIS RACING MUG  
2864716



12oz CAMPER MUG  
2861612



23oz WATER BOTTLE  
2862685



15oz CAMPFIRE MUG  
\* TOP SELLER  
2861613



DECK OF CARDS  
2860816



POLARIS NOTEBOOK  
2860831



HITCH COVER  
2861623



LICENSE PLATE HOLDER  
2862687

ACCESSORIES + GARAGE



LOCK & RIDE FLEX

The fastest attachment system designed for tunnel-mounted snow accessories. Adapter kit sold separately to update a Lock & Ride attachment system to the Lock & Ride Flex system.



LOCK & RIDE

For Snow Accessories, a T-Slot tunnel attachment system.



CAMSO®

Customer-focused, world-class manufacturer and supplier of high-performance snowmobile tracks.

APPAREL



MOUNTAIN APPAREL

Uninsulated outerwear made of TECH54 20k/20k material.



CROSSOVER APPAREL

Insulated outerwear made of TECH54 10k/10k material.



TRAIL APPAREL

Insulated outerwear made of TECH54 5k/5k material.

DOT & ECE 22.06 CERTIFIED

The Department of Transportation (DOT) standard is enforced by the National Highway Traffic Safety Administration (NHTSA). For a helmet to be DOT-certified, it must pass a series of impact tests.

ECE 22.06

The Economic Commission for Europe (ECE) standard, R 22.06, is the most common helmet standard used internationally, as it is recognized by over 50 countries. To be ECE 22.06 certified, the helmet must pass a series of rigorous tests by an independent third-party lab.



3M® THINSULATE® INSULATION

3M® Thinsulate® Insulation is warm yet lightweight, powerful yet thin. It helps trap body heat while allowing moisture to escape.



3M® SCOTCHLITE® REFLECTIVE MATERIAL

Patented 3M® Scotchlite® Reflective Material provides nighttime visibility from every angle.



TECH54

A waterproof and breathable membrane bonded to the shell fabric to block moisture from entering while allowing vapor moisture to escape from the inside.



YKK® ZIPPERS

The YKK® Fastening Products Group is trusted worldwide for impeccable production standards and thorough quality control processes for slide fasteners, plastic hardware, hook-and-loop fasteners, webbing tapes and snap-and-button products.



SUPERIOR DURABLE WATER REPELLENCY

A Superior DWR coating causes water to bead up and run off, preventing precipitation from saturating the exterior of an outerwear piece.



BOA® LACING SYSTEM

The BOA® lacing system is easier to get on and off than traditional lace-up boots. Simply push to engage, turn to tighten and pull for quick release.

SIZING GUIDES

MEN'S JACKETS & BIBS

SIZE	S	M	L	XL	2XL	3XL	MT	LT	XLT	2XLT
SIZE CODE	02	03	06	09	12	14	05	08	11	13
CHEST	34-36	38-40	42-44	46-48	50-52	54-56	38-40	42-44	46-48	50-52
SLEEVE*	33-35	33-35	34-35	34-35	34-35	34-35	33-35	34-35	34-35	34-35
WAIST	31-33	35-37	39-41	43-45	47-49	51-53	35-37	39-41	43-45	47-49
HIPS/SEAT	34-36	38-40	42-44	46-48	50-52	54-56	38-40	42-44	46-48	50-52
INSEAM	30-35	30-35	30-35	30-35	30-35	30-35	36-37	36-37	36-37	36-37

\*MEASURE SLEEVE LENGTH FROM CENTER BACK NECK

WOMEN'S JACKETS & BIBS

SIZE	S	M	L	XL	2XL	3XL
SIZE CODE	02	03	06	09	12	14
CHEST	32-34	35-38	39-42	43-46	47-50	51-54
SLEEVE	29-30	31-33	31-33	31-33	31-33	31-33
WAIST	26-28	29-32	33-36	37-40	41-44	45-48
HIPS/SEAT	35-37	38-41	42-45	46-49	50-53	54-57
INSEAM	26-29	27-30	27-30	27-30	27-30	27-30

SHORT SIZES HAVE 1.5" SHORTER SLEEVES AND INSEAM

YOUTH JACKETS & BIBS

SIZE	S	M	L	XL
SIZE CODE	02	03	06	09
CHEST	25.5-27	27.5-28.5	30-32	33.5
SLEEVE	20-21.5	22-23.5	24-25.5	25.5-27
WAIST	23.5-24.5	25.5-26.5	28-29.5	30-31
INSEAM	21.5-23	23.5-25.5	26-27.5	28-29

HELMETS

SIZE	XS	S	M	L	XL	2XL	3XL	4XL	5XL
SIZE CODE	01	02	03	06	09	12	14	15	16
HAT SIZE	6 3/4	6 7/8-7	7 1/8-7 1/4	7-7 1/2	7 5/8-7 3/4	7 7/8-8	8	8 3/4	8 1/2
CIRCUMFERENCE	20 7/8"-21 1/4" (53-54cm)	21 5/8"-22" (55-56cm)	22 3/8"-22 3/4" (57-58cm)	23 1/8"-23 1/2" (59-60cm)	24"-24 3/8" (61-62cm)	24 3/4"-25 1/8" (63-64cm)	25 1/4"-26" (65cm)	26 3/8"-26 3/4" (66cm)	27 1/8"-27 1/2" (69-79cm)



# POLARIS NORTHSTAR COOLERS

105, 60 & 30 QUART FEATURES



ComfortCarry Handles



TravelLock System



EasyOut Drain System



NoSlip Rubber Feet



PolarWall Insulation



IceLock Seal

## KEEP IT ICE COLD

POLARIS NORTHSTAR COOLERS CAN SURVIVE JUST ABOUT ANYTHING, FROM EXTREME HEAT TO A FULL-ON BEAR ATTACK – IT'S IGBC CERTIFIED BEAR-RESISTANT

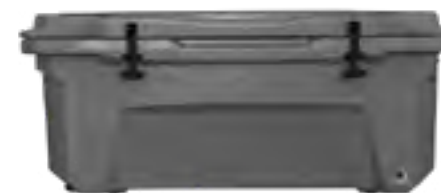

105 Quart



60 Quart



30 Quart



15 Quart



20 Quart Soft-Sided

LEARN ABOUT OUR LINE OF POLARIS NORTHSTAR COOLERS ONLINE AT [SNOWMOBILES.POLARIS.COM/NORTHSTARCOOLERS](http://SNOWMOBILES.POLARIS.COM/NORTHSTARCOOLERS)



**CONNECT ONLINE** SEARCH "POLARISSNOW"

# MAKE IT YOUR OWN

## BUILD YOUR DREAM MACHINE

**1** CHOOSE MODEL

**2** CHOOSE COLOR

**3** CHOOSE OPTIONS

**4** CHOOSE ACCESSORIES



**VISIT POLARIS.COM/SNOW**  
TO SEE ALL YOUR OPTIONS & ACCESSORIES ON  
YOUR NEW SNOWMOBILE FROM EVERY ANGLE!

**POLARIS**  
SNOWMOBILES

FIND EVERYTHING YOU'RE LOOKING FOR AT [POLARIS.COM/SHOP](https://www.polaris.com/shop)

MY25 SNOW PG&A CATALOG-ENGLISH | 9959082

Polaris recommends that all riders take a safety training course. Do not attempt maneuvers beyond your capability. Always wear a helmet and other safety apparel. Read, understand and follow your owner's manual. Never drink and ride. Unless noted, trademarks are the property of Polaris Industries Inc. 3M®, Scotchlite® and Thinsulate® are registered trademarks of 3M Company. 509® and KLIM® are registered trademarks of Teton Outfitters, LLC. Apple® and App Store® are registered trademarks of Apple Inc. ArcticFX® registered trademark of ArcticFXGraphics. Bluetooth® is a registered trademark of Bluetooth Sig, Inc. BOA® is a registered trademark of Boa Technology, Inc. Caliber® is a registered trademark of Caliber, Inc. CAMSO® is a registered trademark of COMPAGNIE GÉNÉRALE DES ÉTABLISSEMENTS MICHELIN SOCIÉTÉ EN COMMANDITE PAR ACTIONS (SCA) FRANCE. Cardo® is a registered trademark of Cardo Systems, Inc. Cordura® is a registered trademark of INVISTA NORTH AMERICA, LLC. CruzTools® is a registered trademark of CYCOACTIVE, INC. Facebook™ is a service trademark of META PLATFORMS, INC. Fidlock® is a registered trademark of Fidlock GmbH. FOX® is a registered trademark of Fox Factory Inc. YouTube™ and Google Play™ are service trademarks of Google LLC. GoPro® is a registered trademark of GOPRO, INC. Ice Lock® is a registered trademark of TrekSta, Inc. Instagram™ is a service trademark of Instagram, LLC. JBL® is a registered trademark of HARMAN INTERNATIONAL INDUSTRIES, INCORPORATED. Kevlar® is a registered trademark of DUPONT SAFETY & CONSTRUCTION, INC. MORFLEX® is a registered trademark of FNA Group, Inc. NGK® is a registered trademark of NGK Spark Plug Co., Ltd. NOCO Boost® and NOCO Genius® are registered trademarks of The Noco Company. OGIO® is a registered trademark of Ogio International, Inc. Otter® is a registered trademark of Otter Outdoors, LLC. PIEPS® is a registered trademark of Pieps GmbH. Alpride® is a registered trademark of RAS technology Sári (Société à responsabilité limitée; SWITZERLAND) ProTaper® is a registered trademark of TURN 14 DISTRIBUTION, INC. SUPERCLAMP® is registered to JPW Industries Inc. Tekvest® is a registered trademark of 1181676 ONTARIO INC. Twitter™ is a service trademark of X Corp. UNRL® is a registered trademark of Michael E. Jordan (INDIVIDUAL, USA). Velcro® is a registered trademark of VELCRO IP HOLDINGS LLC. Vespele® is a registered trademark of DUPONT POLYMERS, INC. Woody's® and Gold Digger® are registered trademarks of INTERNATIONAL ENGINEERING & MANUFACTURING INC. YKK® is a registered trademark of YKK Corporation. RUMPL® is a registered trademark of Rumpl, Inc. All worldwide rights reserved. Other trademarks used in this catalog owned by their respective owners. Fitment and availabilities are subject to change at any moment. Copyright © 2024 Polaris Industries Inc.